

# O3UM-NRG

Multi-Deck Merchandiser with Synerg-E™  
4', 6', 8', 10', 12' (Dairy/Deli/Meat/Produce)

## GENERAL NOTES

- "---" indicates that the feature is not an option for this case model and/or the data is not yet available.
- LED lights only.
- Maximum of 2 rows of standard output LED lighted shelves.
- Nose lights are not available.

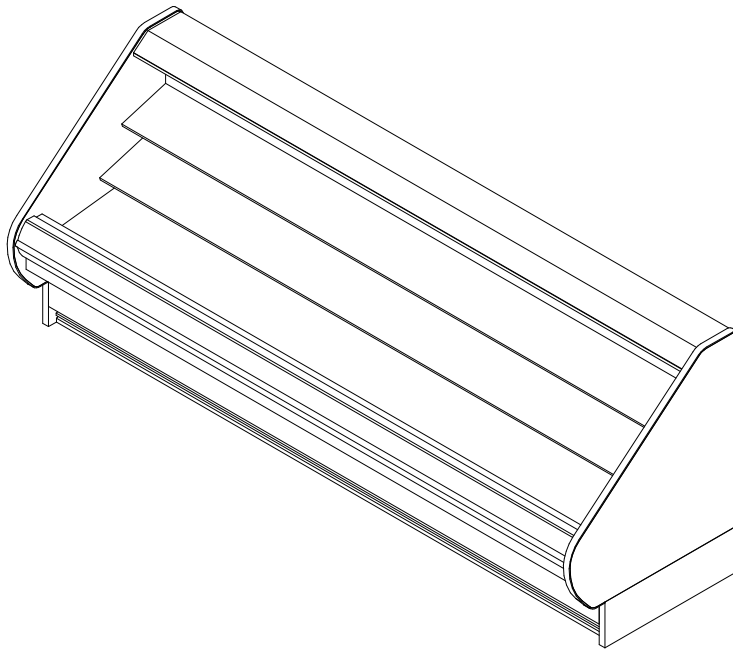

SHIPPING WEIGHT	
Case	Weight
O3UM-NRG	---



ALL MEASUREMENTS ARE TAKEN PER ASHRAE-72-2005 SPECIFICATIONS. HILLPHOENIX REFRIGERATED DISPLAY CASES FOR SALE IN THE UNITED STATES MEET OR EXCEED DEPARTMENT OF ENERGY 2017 REQUIREMENTS.

## O3UM-NRG

Rev. Date	Rev. #	Rev. Title
7-1-19	4	ENDVIEW UPDATE
9-10-18	3	DATA UPDATE

**Hillphoenix**  
A DOVER COMPANY

# O3UM-NRG

Multi-Deck Merchandiser with Synerg-E™  
4', 6', 8', 10' 12' (Dairy/Deli/Meat/Produce)

ELECTRICAL DATA			
Case Length	Fans Per Case	High Efficiency Fans	
		120 Volts	
		Amps	Watts
4'	1	0.16	11.0
6'	2	0.32	22.0
8'	2	0.32	22.0
10'	3	0.48	33.0
12'	3	0.48	33.0

LIGHTING DATA						
Case Length	Lights per row	Lights Length	Clearvoyant LED Lighting (Per Light Row)			
			Standard Power (Cornice or Shelf)		High Power (Cornice)	
			120 Volts		120 Volts	
			Amps	Watts	Amps	Watts
4'	1	4'	0.05	5.9	0.12	14.9
6'	2	3'	0.08	9.4	0.20	23.8
8'	2	4'	0.10	11.8	0.25	29.9
10'	3	3 3/4'	0.13	15.3	0.32	38.7
12'	3	4'	0.15	17.6	0.37	44.8

GUIDELINES AND CONTROL SETTINGS							
Application	Front Sill Height	BTUH/ft		Superheat Set Point @ Bulb (°F)	Evaporator (°F)	Discharge Air (°F)	Discharge Air Velocity (FPM)
		Conventional	Parallel				
Dairy/Deli/Produce	All	830	770	6 - 8	28	31	180
Meat	Extended	830	750	6 - 8	26	30	180

DEFROST CONTROLS		
Defrosts Per Day	Timed-Off Defrost	
	Fail-Safe (Min)	Termination Temp (°F)
6	30	47

## NOTES

- "—" indicates that the feature is not an option for this case model and/or the data is not yet available.
- Listed BTUH/ft data represent unlighted shelves. For LED lighting, add 9 BTUH/ft per row of lighted shelving. BTUH load increases by 132 BTUH/ft when aftermarket merchandising accessories are utilized.
- Listed evaporator temperature represents unlighted shelves. For lighted shelves and/or aftermarket merchandising accessories, reduce the listed evaporator temperature by 2°F.
- Conventional Discharge Air Control – Recommended Settings: Cut-In Temp = Discharge Air + 2°F; Cut-Out Temp = Discharge Air - 2°F.
- Listed discharge air velocity represents the average velocity immediately after defrost.
- Temperature and defrost settings listed above are recommended start-up settings. Final operational settings may need to be adjusted for the store conditions in which the case operates.
- The recommended evaporator temperatures may need to be adjusted based on system setup, store conditions, etc. The minimum recommended evaporator temperature is 4°F below the listed evaporator temperature.



ALL MEASUREMENTS ARE TAKEN PER ASHRAE-72-2005 SPECIFICATIONS. HILLPHOENIX REFRIGERATED DISPLAY CASES FOR SALE IN THE UNITED STATES MEET OR EXCEED DEPARTMENT OF ENERGY 2017 REQUIREMENTS.

## O3UM-NRG

Rev. Date	Rev. #	Rev. Title
7-1-19	4	ENDVIEW UPDATE
9-10-18	3	DATA UPDATE

**Hillphoenix**  
A DOVER COMPANY

# O3UM-NRG

Multi-Deck Merchandiser with Synerg-E™  
4', 6', 8', 10' 12' (Dairy/Deli/Meat/Produce)

SECOND NATURE DATA								
Case Model	No. of Coils	Application	Front Sill height	BTUH/FT		GPM/ft (DR)	Supply Fluid Temp (°F)	Discharge Air Temp (°F)
				Conventional	Parallel			
O3UM-NRG	1	Bulk Produce	Standard	926	810	0.11	20	38
O3UM-NRG	1	Deli/Produce	Standard	926	810	0.23	20	31
O3UM-NRG	1	Meat	3" Extended	915	800	0.28	20	30
O3UM-NRG	1	Bulk Produce	Standard	926	810	0.19	25	38
O3UM-NRG	1	Deli/Produce	Standard	926	810	0.60	25	31
O3UM-NRG	1	Meat	3" Extended	915	800	0.83	25	30

SECOND NATURE DATA									
Case Model	No. of Coils	Application	Front Sill height	Supply Fluid Temp (°F)	No. of Defrost	Timed-Off Defrost		Warm Fluid Defrost	
						Fail-Safe (Min)	Termination Temp (°F)	Fail-Safe (Min)	Termination Temp (°F)
O3UM-NRG	1	Bulk Produce	Standard	20	6	60	47	26	49
O3UM-NRG	1	Deli/Produce	Standard	20	6	60	47	26	49
O3UM-NRG	1	Meat	3" Extended	20	6	60	47	26	49
O3UM-NRG	1	Bulk Produce	Standard	25	6	45	42	26	49
O3UM-NRG	1	Deli/Produce	Standard	25	6	45	42	26	49
O3UM-NRG	1	Meat	3" Extended	25	6	45	42	26	49

## NOTES

- All medium temperature data listed is for 35% by wt. PROPYLENE GLYCOL.
- Inhibited Propylene Glycol solution with water, such as Dowfrost or equivalent. (Dowfrost is a trademark of the Dow Chemical Company).
- Flowrates are determined by ASHRAE test conditions and may need to be adjusted based on store conditions.
- \*\* Flowrates are per case



ALL MEASUREMENTS ARE TAKEN PER ASHRAE-72-2005 SPECIFICATIONS. HILLPHOENIX REFRIGERATED DISPLAY CASES FOR SALE IN THE UNITED STATES MEET OR EXCEED DEPARTMENT OF ENERGY 2017 REQUIREMENTS.





## O3UM-NRG

Rev. Date	Rev. #	Rev. Title
7-1-19	4	ENDVIEW UPDATE
9-10-18	3	DATA UPDATE

**Hillphoenix**  
A DOVER COMPANY

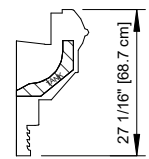
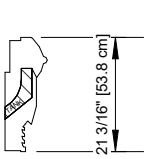
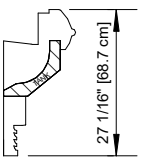
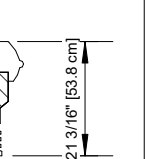
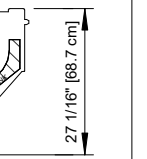
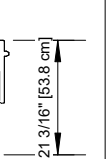
# O3UM-NRG

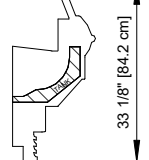
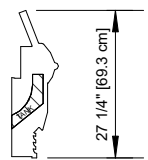
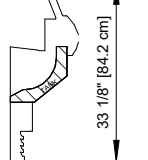
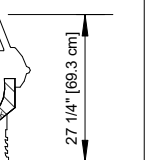
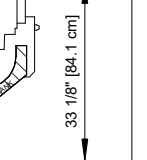
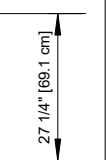
Multi-Deck Merchandiser with Synerg-E™  
4', 6', 8', 10' 12' (Dairy/Deli/Meat/Produce)

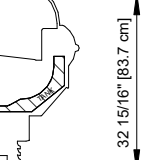
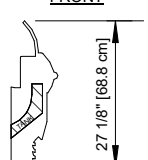
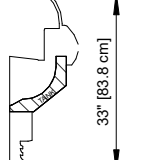
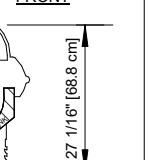
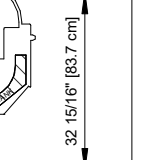
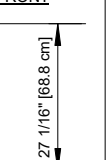
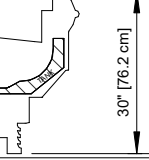
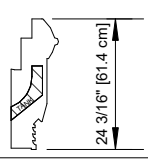
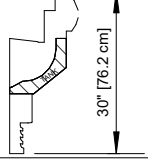
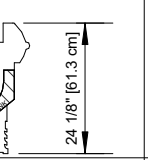
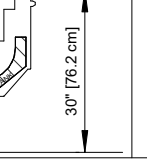
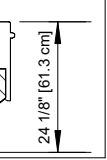
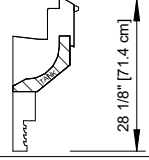
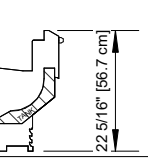
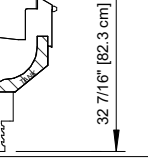
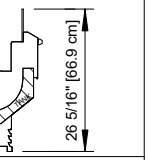
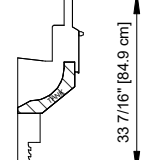
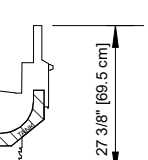
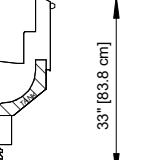
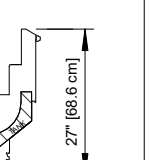
REAR SILL OPTIONS	FRONT OPTIONS					
	ORIGIN 2 FRONT				FLAT FRONT FLAT TOP	
	STANDARD FRONT	STANDARD FRONT	STANDARD FRONT	STANDARD FRONT	STANDARD FRONT	STANDARD FRONT
<b>STANDARD REAR SILL</b>  8 9/16" [21.7 cm]						
<b>12 1/2" REAR SILL</b>  12 7/16" [31.7 cm]						
<b>16" REAR SILL (REAR DISCHARGE)</b>  16 1/16" [40.7 cm]						
	<b>EXTENDED STANDARD FRONT</b> 	<b>EXTENDED STANDARD FRONT</b> 	<b>EXTENDED STANDARD FRONT</b> 	<b>EXTENDED STANDARD FRONT</b> 	<b>EXTENDED STANDARD FRONT</b> 	<b>EXTENDED STANDARD FRONT</b> 
	FLAT FRONT ANGLED TOP					
	<b>STANDARD FRONT</b> 	<b>STANDARD FRONT</b> 	<b>6" PLEXIGLAS FRONT</b> 	<b>6" PLEXIGLAS FRONT</b> 		
	<b>6" THERMOPANE FRONT</b> 	<b>6" THERMOPANE FRONT</b> 	<b>EXTENDED STANDARD FRONT</b> 	<b>EXTENDED STANDARD FRONT</b> 		

**NOTES:**

- Front and rear sill heights vary with base frame height.
- Extended front sills are required for meat applications to maintain proper product temperature. An extended front has a minimum height of 24" on a 5" baseframe, or 30" on an 11" baseframe.



ALL MEASUREMENTS ARE TAKEN PER ASHRAE-72-2005 SPECIFICATIONS. HILLPHOENIX REFRIGERATED DISPLAY CASES FOR SALE IN THE UNITED STATES MEET OR EXCEED DEPARTMENT OF ENERGY 2017 REQUIREMENTS.

## O3UM-NRG

Rev. Date	Rev. #	Rev. Title
7-1-19	4	ENDVIEW UPDATE
9-10-18	3	DATA UPDATE



# O3UM-NRG

Multi-Deck Merchandiser with Synerg-E™  
4', 6', 8', 10' 12' (Dairy/Deli/Meat/Produce)

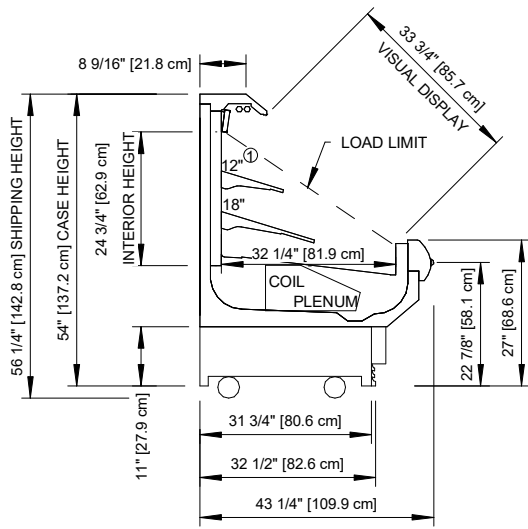

**11" BASE FRAME**

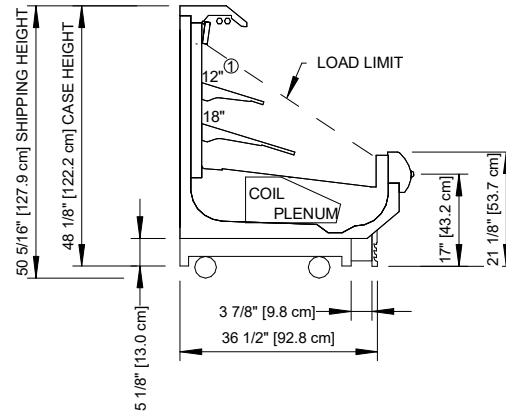

**5" BASE FRAME**

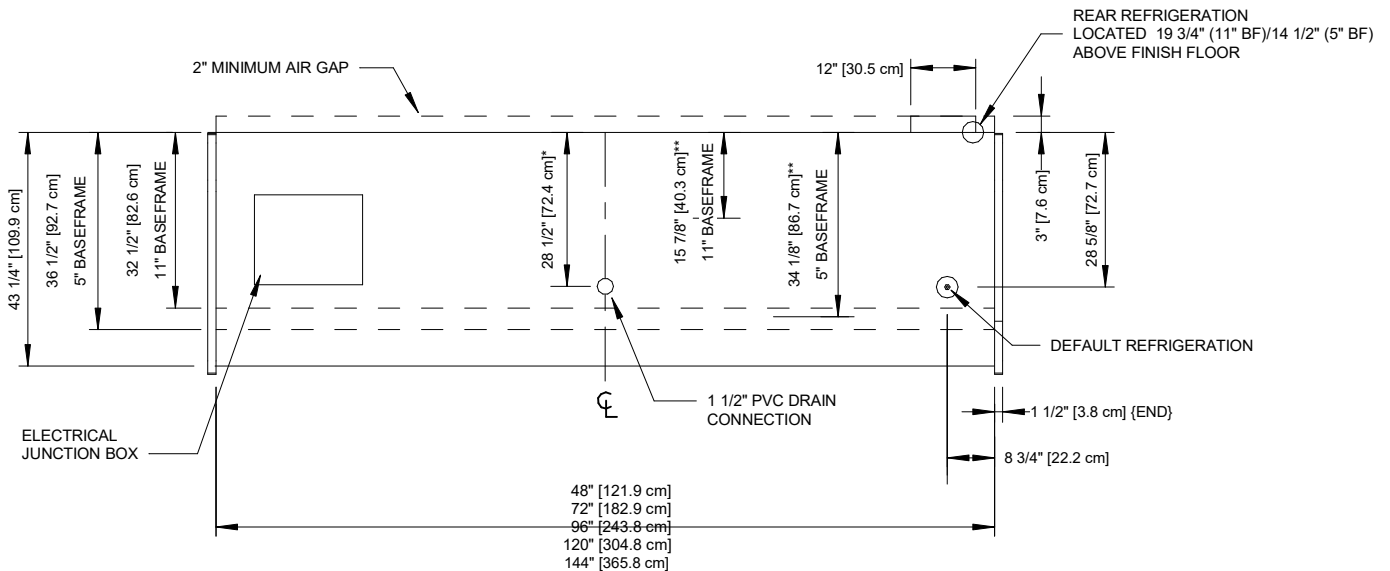

**NOTES**

- \* :STUB-UP AREA
- \*\* :RECOMMENDED STUB-UP CENTERLINE FOR ELECTRICAL AND HUB DRAINS
- ① :AVAILABLE SHELF SIZES: 10", 12", 14", 16", & 18"

• Ends add approximately 1" to case height, 1" to the front and 1/2" to the back.



ALL MEASUREMENTS ARE TAKEN PER ASHRAE-72-2005 SPECIFICATIONS. HILLPHOENIX REFRIGERATED DISPLAY CASES FOR SALE IN THE UNITED STATES MEET OR EXCEED DEPARTMENT OF ENERGY 2017 REQUIREMENTS.

**O3UM-NRG**

Rev. Date	Rev. #	Rev. Title
7-1-19	4	ENDVIEW UPDATE
9-10-18	3	DATA UPDATE

