

O5MA-NRG

8' Multi-Deck Merchandiser
Deli / Meat / Seafood

GENERAL NOTES

- " - - -" indicates that the feature is not an option for this case model and/or the data is not yet available.
- LED lights only.
- Maximum of 5 rows of standard output LED lighted shelves.

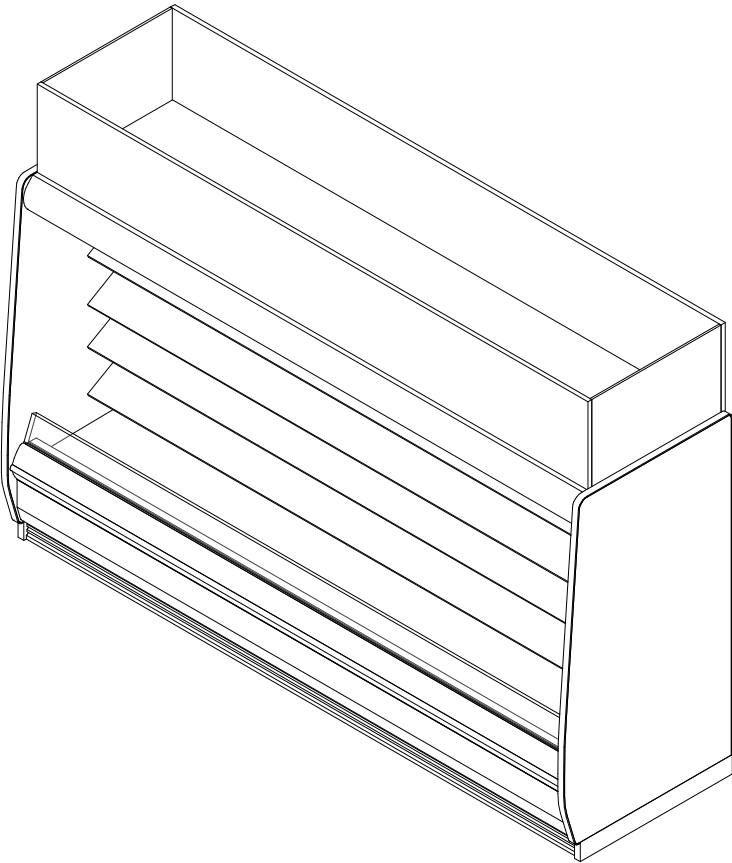

SHIPPING WEIGHT	
Case	Weight
O5MA-NRG	---



ALL MEASUREMENTS ARE TAKEN PER ASHRAE-72-2005 SPECIFICATIONS. HILLPHOENIX REFRIGERATED DISPLAY CASES FOR SALE IN THE UNITED STATES MEET OR EXCEED DEPARTMENT OF ENERGY 2017 REQUIREMENTS.

O5MA-NRG

Rev. Date	Rev. #	Rev. Title
1-7-21	5	DATA UPDATE
10-16-18	4	ENDVIEW UPDATE



O5MA-NRG

8' Multi-Deck Merchandiser
Deli / Meat / Seafood

SYSTEM REQUIREMENTS					
Volts	Phase	Frequency (Hz)	Plug	Minimum Circuit Ampacity	Maximum Overcurrent Protection
208	1	60	NEMA L14-30	29.4	40

ELECTRICAL DATA				
Fans Per Case	High Efficiency Fans		Drain Pan	
	120 Volts		120 Volts	
	Amps	Watts	Amps	Watts
4	0.8	64.7	7.2	1500.0

LIGHTING DATA			
Lights Per Row	Light Length	Standard Power (Cornice or Shelf)	
		120 Volts	
		Amps	Watts
1	4	0.05	5.90

GUIDELINES AND CONTROL SETTINGS				
24hr Energy Usage (kWh)	Suction Pressure @ Case Outlet (psig)	Superheat Set Point @ Bulb (°F)	Discharge Air (°F)	Discharge Air Velocity (FPM)
48.31	47	6 - 8	30	135

CONDENSING UNIT DATA						
Volts	Phase	Frequency (Hz)	Running Load Amps (RLA) (Amps)	Locked Rotor Amps (LRA) (Amps)	Refrigerant	Lbs. of Refrigerant (Lbs)
208	1	60	15.7	68.0	R448A	6.3

DEFROST CONTROLS		
Defrosts Per Day	Timed-Off Defrost	
	Fail-Safe (Min)	Termination Temp (F)
6	45	42

NOTES

- "---" indicates that the feature is not an option for this case model and/or the data is not yet available.
- Listed discharge air velocity represents the average velocity immediately after defrost.
- Temperature and defrost settings listed below are recommended start-up settings. Final operational settings may need to be adjusted for the store conditions in which the case operates.
- The recommended evaporator temperatures may need to be adjusted based on system setup, store conditions, etc. The minimum recommended evaporator temperature is 4°F below the listed evaporator temperature.



ALL MEASUREMENTS ARE TAKEN PER ASHRAE-72-2005 SPECIFICATIONS. HILLPHOENIX REFRIGERATED DISPLAY CASES FOR SALE IN THE UNITED STATES MEET OR EXCEED DEPARTMENT OF ENERGY 2017 REQUIREMENTS.

O5MA-NRG

Rev. Date	Rev. #	Rev. Title
1-7-21	5	DATA UPDATE
10-16-18	4	ENDVIEW UPDATE

Hillphoenix
A DOVER COMPANY

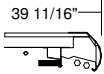
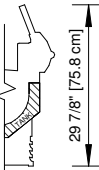
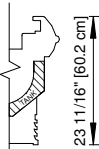
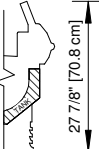
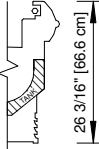
CORNICE OPTIONS	FRONT OPTIONS	
	THERMOPANE	ORIGIN 2
<u>CURVED CORNICE</u>  39 11/16"	<u>6" THERMOPANE FRONT</u>  29 7/8" [75.8 cm]	<u>23" FRONT & W/O NOSE LIGHT</u>  23 11/16" [60.2 cm]
	<u>4" THERMOPANE FRONT</u>  27 7/8" [70.8 cm]	<u>26" FRONT</u>  26 3/16" [66.6 cm]



ALL MEASUREMENTS ARE TAKEN PER ASHRAE-72-2005 SPECIFICATIONS. HILLPHOENIX REFRIGERATED DISPLAY CASES FOR SALE IN THE UNITED STATES MEET OR EXCEED DEPARTMENT OF ENERGY 2017 REQUIREMENTS.

O5MA-NRG

Rev. Date	Rev. #	Rev. Title
1-7-21	5	DATA UPDATE
10-16-18	4	ENDVIEW UPDATE

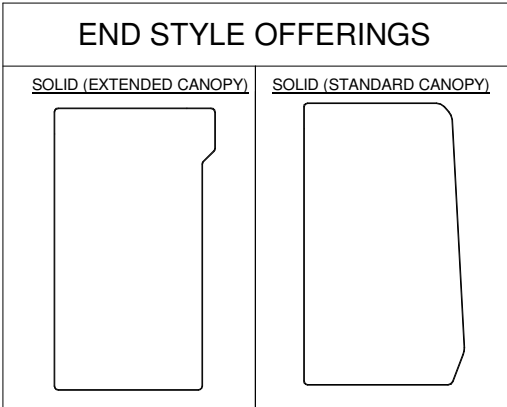

NOTES:

- Ends shown are for general use only. Shape, size, and appearance are subject to change based on engineering configuration.
- Hatched regions represent glass inserts.
- Ends add approximately 1" to case height, 1/2" to the back & 1" to the front.
- Ends are available with either polymer end trim or metal end trim.



ALL MEASUREMENTS ARE TAKEN PER ASHRAE-72-2005 SPECIFICATIONS. HILLPHOENIX REFRIGERATED DISPLAY CASES FOR SALE IN THE UNITED STATES MEET OR EXCEED DEPARTMENT OF ENERGY 2017 REQUIREMENTS.

O5MA-NRG

Rev. Date	Rev. #	Rev. Title
1-7-21	5	DATA UPDATE
10-16-18	4	ENDVIEW UPDATE



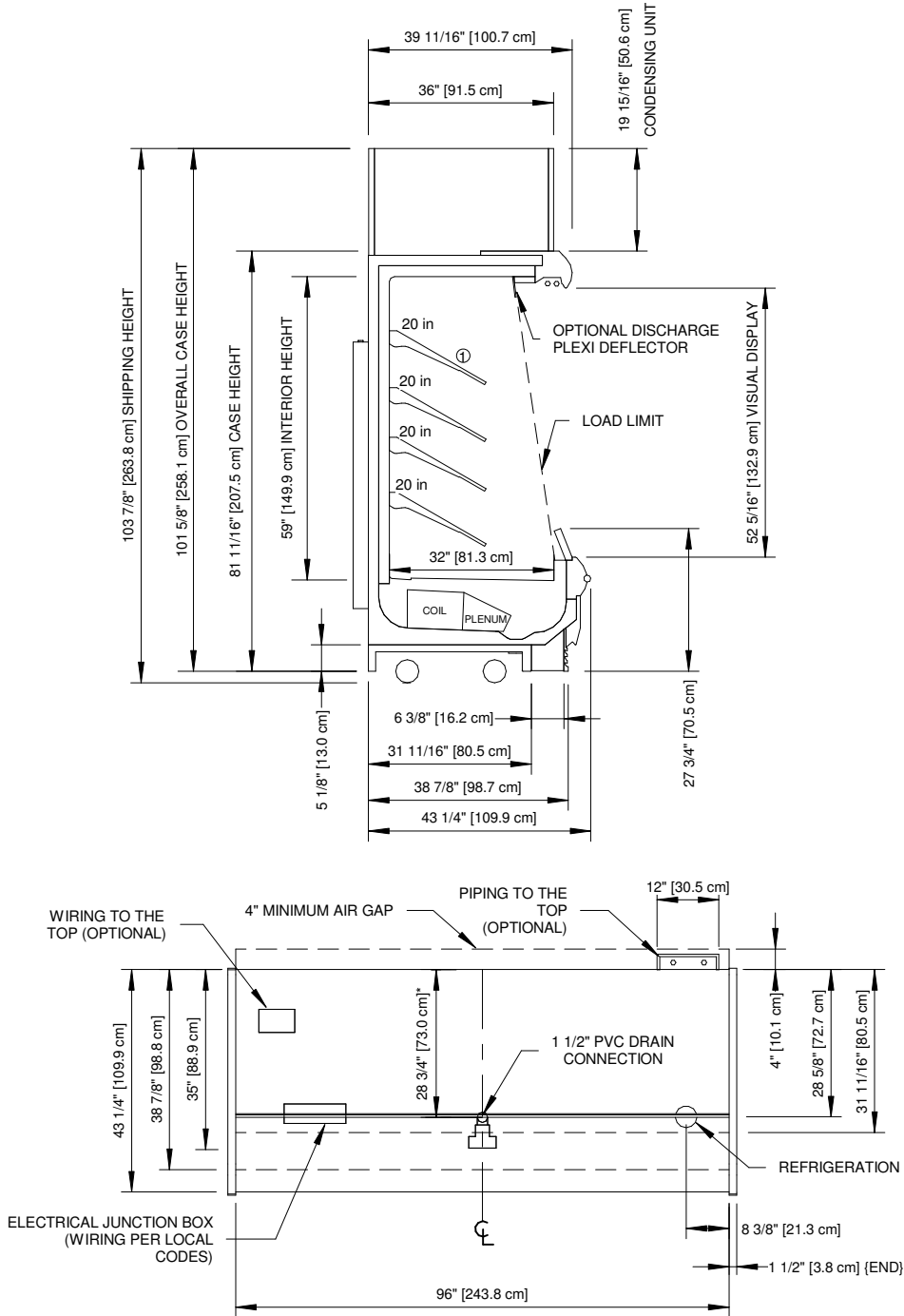

NOTES:

- * : STUB-UP AREA
- ** : RECOMMENDED STUB-UP CENTERLINE FOR ELECTRICAL AND HUB DRAINS
- ① : AVAILABLE SHELF SIZES: 18", 20", 22", & 24" ARTICULATING OR 20", 22", & 24" STANDARD

- Ends add approximately 1" to case height, 1" to the front and 1/2" to case height.



ALL MEASUREMENTS ARE TAKEN PER ASHRAE-72-2005 SPECIFICATIONS. HILLPHOENIX REFRIGERATED DISPLAY CASES FOR SALE IN THE UNITED STATES MEET OR EXCEED DEPARTMENT OF ENERGY 2017 REQUIREMENTS.

O5MA-NRG

Rev. Date	Rev. #	Rev. Title
1-7-21	5	DATA UPDATE
10-16-18	4	ENDVIEW UPDATE

