

OM-NRG

4', 6', 8' & 12' Single-Deck Merchandiser
Deli / Meat / Seafood

GENERAL NOTES:

- " --- " indicates that the feature is not an option with this case model and/or that the data is not available at this time.

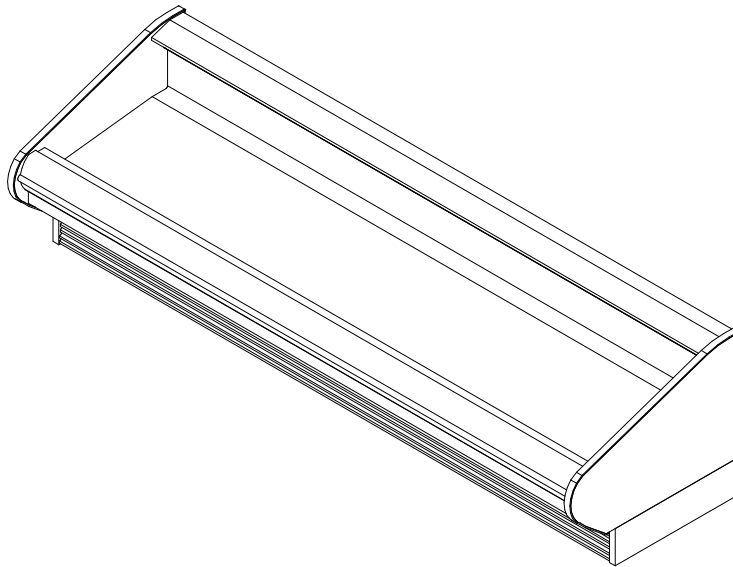

SHIPPING WEIGHT	
Case	Weight
OM-NRG	---



ALL MEASUREMENTS ARE TAKEN PER ASHRAE-72-2005 SPECIFICATIONS. HILLPHOENIX REFRIGERATED DISPLAY CASES FOR SALE IN THE UNITED STATES MEET OR EXCEED DEPARTMENT OF ENERGY 2017 REQUIREMENTS.

OM-NRG

Rev. Date	Rev. #	Rev. Title
12-2-19	5	DATA UPDATE
12-1-19	4	DATA UPDATE

Hillphoenix
A DOVER COMPANY

OM-NRG

4', 6', 8' & 12' Single-Deck Merchandiser
Deli / Meat / Seafood

ELECTRICAL DATA					
Case Length	Fans Per Case	High Efficiency Fans		Anti Condensate Heaters	
		Open Case		120 Volts	
		120 Volt		Amps	Watts
Amps	Watts				
4'	1	0.16	11.0	0.10	8.0
6'	2	0.32	21.0	0.20	15.0
8'	2	0.32	21.0	0.20	15.0
12'	3	0.48	32.0	0.30	23.0

LIGHTING DATA						
Case Length	Lights per row	Light Length	Clearvoyant v4 LED Lighting (Per Light Row)			
			Standard Power (Cornice or Shelf)		High Power (Cornice Only)	
			120 Volts		120 Volts	
Amps	Watts	Amps	Watts			
4'	1	4'	0.10	11.9	0.18	21.5
6'	2	3'	0.14	16.6	0.25	29.8
8'	2	4'	0.20	23.8	0.36	43.0
12'	3	4'	0.30	35.7	0.54	64.5

GUIDELINES AND CONTROL DATA							
Front Sill Height	Case Type	BTUH/ft		Superheat Set Point @ Bulb (°F)	Evaporator (°F)	Discharge Air (°F)	Discharge Air Velocity (FPM)
		Conventional	Parallel				
Standard	Open	488	420	6 - 8	28	30	165
All Other	Open	499	430	6 - 8	26	28	165

DEFROST CONTROLS				
Case Type	Defrosts Per Day	Run Off Time (Min)	Timed-Off Defrost	
			Fail-Safe (Min)	Termination Temp (°F)
Open	4	6 - 8	60	47

NOTES:

- " --- " indicates that the feature is not an option with this case model and/or that the data is not available at this time.
- Listed anti-condensate heater data represent an unlighted rear sill. For a lighted rear sill, the values must be doubled.
- Listed discharge air velocity represents the average velocity immediately after defrost.
- Temperature and defrost settings listed above are recommended start-up settings. Final operational settings may need to be adjusted for the store conditions in which the case operates.
- The recommended evaporator temperatures may need to be adjusted based on system setup, store conditions, etc. The minimum recommended evaporator temperature is 4°F below the listed evaporator temperature.



ALL MEASUREMENTS ARE TAKEN PER ASHRAE-72-2005 SPECIFICATIONS. HILLPHOENIX REFRIGERATED DISPLAY CASES FOR SALE IN THE UNITED STATES MEET OR EXCEED DEPARTMENT OF ENERGY 2017 REQUIREMENTS.

OM-NRG

Rev. Date	Rev. #	Rev. Title
12-2-19	5	DATA UPDATE
12-1-19	4	DATA UPDATE

Hillphoenix
A DOVER COMPANY

OM-NRG

4', 6', 8' & 12' Single-Deck Merchandiser
Deli / Meat / Seafood

SECOND NATURE DATA

Case Model	No. of Coils	Application	Front Sill height	BTUH/FT		GPM/ft (DR)	Supply Fluid Temp (°F)	Discharge Air Temp (°F)
				Conventional	Parallel			
OM-NRG	1	Deli	Standard	488	420	0.14	20	30
OM-NRG	1	Meat	Standard	499	430	0.14	20	28
OM-NRG	1	Deli	Standard	488	420	0.42	25	30

SECOND NATURE DATA

Case Model	No. of Coils	Application	Front Sill height	Supply Fluid Temp (°F)	No. of Defrost	Timed-Off Defrost		Warm Fluid Defrost	
						Fail-Safe (Min)	Termination Temp (°F)	Fail-Safe (Min)	Termination Temp (°F)
OM-NRG	1	Deli	Standard	20	4	60	47	26	49
OM-NRG	1	Meat	Standard	20	4	60	47	26	49
OM-NRG	1	Deli	Standard	25	4	45	42	26	49

NOTES:

- All medium temperature data listed is for 35% by wt. PROPYLENE GLYCOL.
- Inhibited Propylene Glycol solution with water, such as Dowfrost or equivalent. (Dowfrost is a trademark of the Dow Chemical Company).
- Flowrates are determined by ASHRAE test conditions and may need to be adjusted based on store conditions.
- ** Flowrates are per case





ALL MEASUREMENTS ARE TAKEN PER ASHRAE-72-2005 SPECIFICATIONS. HILLPHOENIX REFRIGERATED DISPLAY CASES FOR SALE IN THE UNITED STATES MEET OR EXCEED DEPARTMENT OF ENERGY 2017 REQUIREMENTS.

OM-NRG

Rev. Date	Rev. #	Rev. Title
12-2-19	5	DATA UPDATE
12-1-19	4	DATA UPDATE

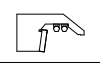
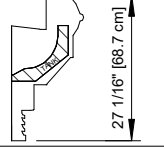
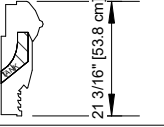
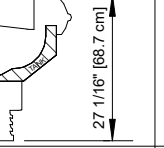
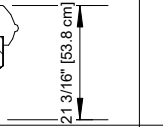
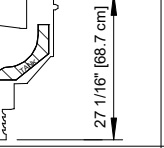
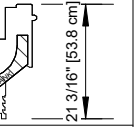
Hillphoenix
A DOVER COMPANY

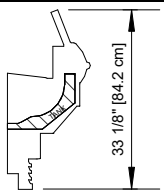
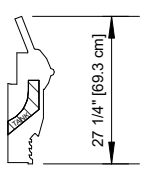
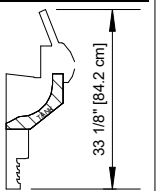
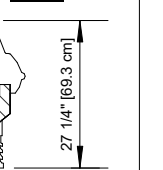
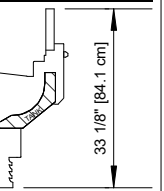
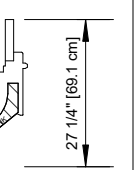
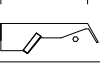
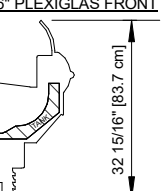
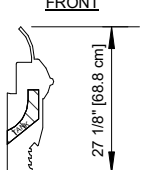
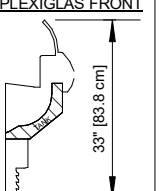
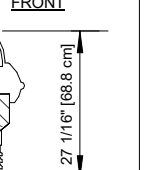
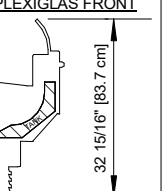
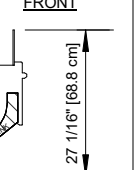
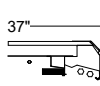
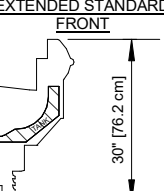
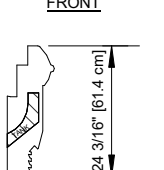
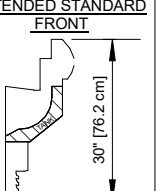
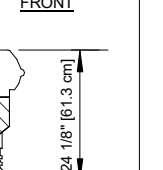
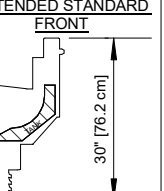
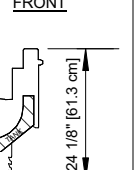
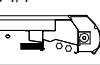
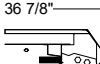
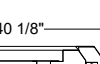
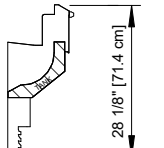
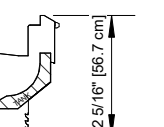
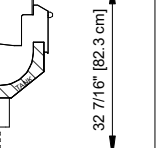
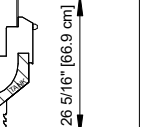
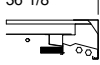
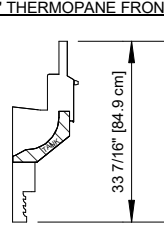
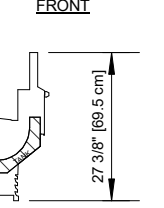
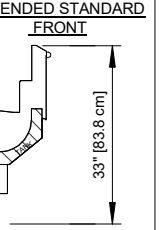
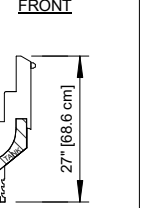
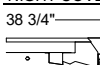
REAR SILL OPTIONS	FRONT OPTIONS					
	ORIGIN 2 FRONT				FLAT FRONT FLAT TOP	
STANDARD REAR SILL 8 9/16" [21.7 cm] 	STANDARD FRONT  27 1/16" [68.7 cm]	STANDARD FRONT  21 3/16" [53.8 cm]	STANDARD FRONT  27 1/16" [68.7 cm]	STANDARD FRONT  21 3/16" [53.8 cm]	STANDARD FRONT  27 1/16" [68.7 cm]	STANDARD FRONT  21 3/16" [53.8 cm]
12 1/2" REAR SILL 12 7/16" [31.7 cm] 	6" THERMOPANE FRONT  33 1/8" [84.2 cm]	6" THERMOPANE FRONT  27 1/4" [69.3 cm]	6" THERMOPANE FRONT  33 1/8" [84.2 cm]	6" THERMOPANE FRONT  27 1/4" [69.3 cm]	6" THERMOPANE FRONT  33 1/8" [84.1 cm]	6" THERMOPANE FRONT  27 1/4" [69.1 cm]
16" REAR SILL (REAR DISCHARGE) 16 1/16" [40.7 cm] 	6" PLEXIGLAS FRONT  32 15/16" [83.7 cm]	6" PLEXIGLAS FRONT  27 1/8" [68.8 cm]	6" PLEXIGLAS FRONT  33" [83.8 cm]	6" PLEXIGLAS FRONT  27 1/16" [68.8 cm]	6" PLEXIGLAS FRONT  32 15/16" [83.7 cm]	6" PLEXIGLAS FRONT  27 1/16" [68.8 cm]
CORNICE OPTIONS						
CURVED CORNICE 37" 	EXTENDED STANDARD FRONT  30" [76.2 cm]	EXTENDED STANDARD FRONT  24 3/16" [61.4 cm]	EXTENDED STANDARD FRONT  30" [76.2 cm]	EXTENDED STANDARD FRONT  24 1/8" [61.3 cm]	EXTENDED STANDARD FRONT  30" [76.2 cm]	EXTENDED STANDARD FRONT  24 1/8" [61.3 cm]
CURVED CORNICE WITH NIGHT COVER 40 1/4" 						
FACETED CORNICE 36 7/8" 						
FACETED CORNICE WITH NIGHT COVER 40 1/8" 	STANDARD FRONT  28 1/8" [71.4 cm]	STANDARD FRONT  22 5/16" [56.7 cm]	6" PLEXIGLAS FRONT  32 7/16" [82.3 cm]	6" PLEXIGLAS FRONT  26 5/16" [66.9 cm]		
FLAT CORNICE 36 1/8" 	6" THERMOPANE FRONT  33 7/16" [84.9 cm]	6" THERMOPANE FRONT  27 3/8" [69.5 cm]	EXTENDED STANDARD FRONT  33" [83.8 cm]	EXTENDED STANDARD FRONT  27" [68.6 cm]		
FLAT CORNICE WITH STANDARD NIGHT COVER 38 3/4" 						

NOTES:

- Extended front sills are required for meat applications to maintain proper product temperature. An extended front has a minimum height of 24" on a 5" baseframe, or 30" on an 11" baseframe.



ALL MEASUREMENTS ARE TAKEN PER ASHRAE-72-2005 SPECIFICATIONS. HILLPHOENIX REFRIGERATED DISPLAY CASES FOR SALE IN THE UNITED STATES MEET OR EXCEED DEPARTMENT OF ENERGY 2017 REQUIREMENTS.

OM-NRG

Rev. Date	Rev. #	Rev. Title
12-2-19	5	DATA UPDATE
12-1-19	4	DATA UPDATE



A DOVER COMPANY

OM-NRG

4', 6', 8' & 12' Single-Deck Merchandiser
Deli / Meat / Seafood

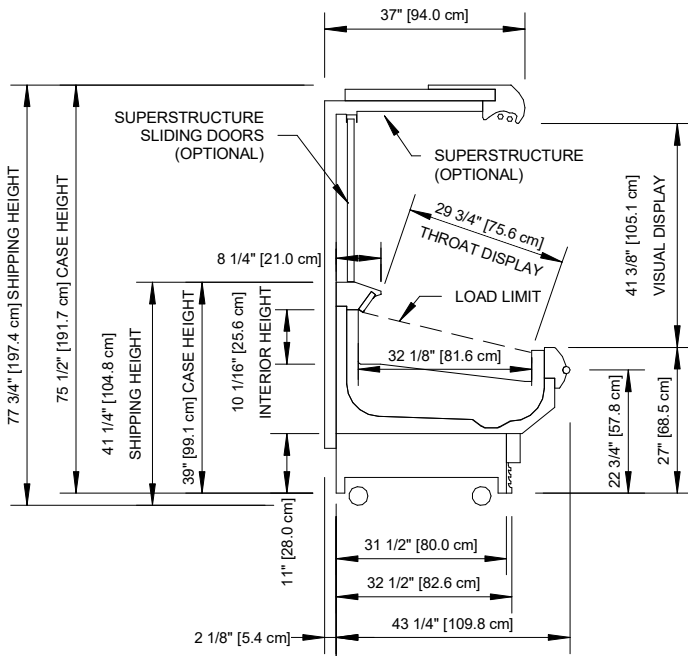

11" BASEFRAME

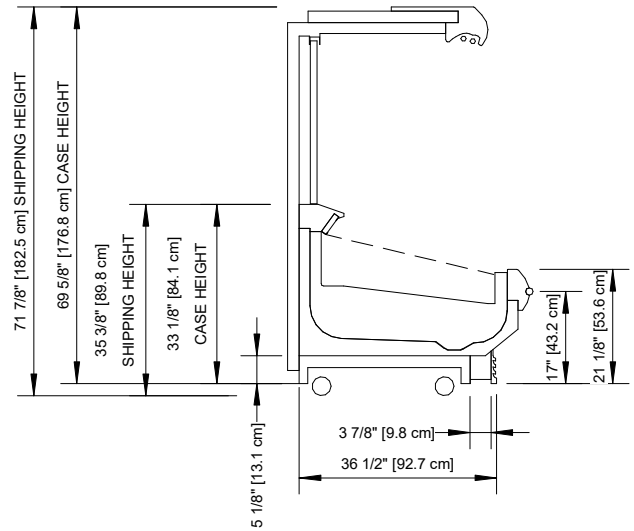

5" BASEFRAME

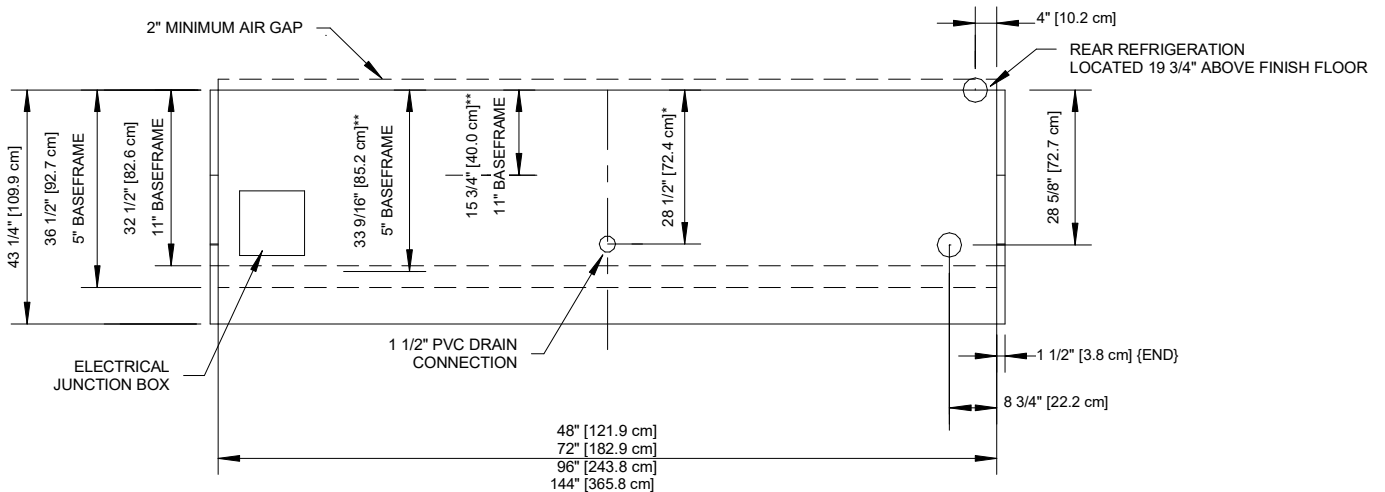

NOTES:

- * : STUB-UP AREA
- ** : RECOMMENDED STUB-UP CENTERLINE FOR ELECTRICAL AND HUB DRAINS

• Ends add approximately 1" to case height.



ALL MEASUREMENTS ARE TAKEN PER ASHRAE-72-2005 SPECIFICATIONS. HILLPHOENIX REFRIGERATED DISPLAY CASES FOR SALE IN THE UNITED STATES MEET OR EXCEED DEPARTMENT OF ENERGY 2017 REQUIREMENTS.

OM-NRG

Rev. Date	Rev. #	Rev. Title
12-2-19	5	DATA UPDATE
12-1-19	4	DATA UPDATE

