

GENERAL NOTES

- "---" indicates that the feature is not an option on this case model and/or the data is not yet available yet.

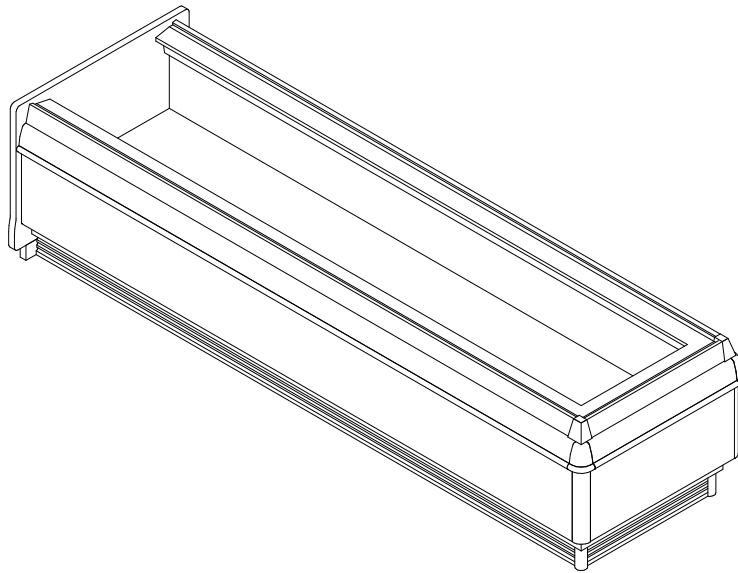

| SHIPPING WEIGHT | |
|-----------------|--------|
| Case | Weight |
| ONIZ | --- |



ALL MEASUREMENTS ARE TAKEN PER ASHRAE-72-2005 SPECIFICATIONS. HILLPHOENIX REFRIGERATED DISPLAY CASES FOR SALE IN THE UNITED STATES MEET OR EXCEED DEPARTMENT OF ENERGY 2017 REQUIREMENTS.

ONIZ

| Rev. Date | Rev. # | Rev. Title |
|-----------|--------|----------------|
| 9-14-20 | 4 | OPTIONS UPDATE |
| 4-9-20 | 3 | DATA UPDATE |

| ELECTRICAL DATA | | | | | | | | | |
|-----------------|---------------|----------------------|-------|--------------|-------|---------------------------|-------|-----------|-------|
| Case Length | Fans Per Case | High Efficiency Fans | | Drain Heater | | Defrost Heaters (1-Phase) | | | |
| | | 120 Volt | | 120 Volts | | 208 Volts | | 240 Volts | |
| | | Amps | Watts | Amps | Watts | Amps | Watts | Amps | Watts |
| 6' | 2 | 0.30 | 22.0 | 0.13 | 15 | 11.60 | 2400 | 13.30 | 3196 |
| 8' | 2 | 0.30 | 22.0 | 0.13 | 15 | 11.60 | 2400 | 13.30 | 3196 |
| 10' | 3 | 0.45 | 33.0 | 0.13 | 15 | 14.40 | 3000 | 16.70 | 3994 |
| 12' | 3 | 0.45 | 33.0 | 0.13 | 15 | 17.30 | 3600 | 20.00 | 4795 |

| ANTI CONDENSATE DATA | | | | | | | | |
|----------------------|-------------|-------|-------------|-------|-----------------------|-------|----------------|-------|
| Case Length | Solid Front | | Glass Front | | Glass Front Glass Cap | | Glass Wrap End | |
| | 120 Volts | | 120 Volts | | 120 Volts | | 120 Volts | |
| | Amps | Watts | Amps | Watts | Amps | Watts | Amps | Watts |
| 6' | 0.50 | 60.0 | 0.79 | 70.0 | 0.37 | 44.0 | 0.22 | 26.4 |
| 8' | 0.75 | 90.0 | 1.33 | 160.0 | 0.42 | 50.0 | 0.22 | 26.4 |
| 10' | 1.20 | 111.0 | --- | --- | --- | --- | 0.22 | 26.4 |
| 12' | 1.42 | 120.0 | 1.69 | 240.0 | 0.74 | 89.0 | 0.22 | 26.4 |

| GUIDELINES AND CONTROL DATA | | | | | | | | | | | |
|-----------------------------|--------------|----------|--------------|----------|---------------------------------|-----------------|-------------|--------------------|-------------|------------------------------|-------------|
| Application | BTUH/ft | | | | Superheat Set Point @ Bulb (°F) | Evaporator (°F) | | Discharge Air (°F) | | Discharge Air Velocity (FPM) | |
| | Solid Front | | Glass Front | | | Solid Front | Glass Front | Solid Front | Glass Front | Solid Front | Glass Front |
| | Conventional | Parallel | Conventional | Parallel | | | | | | | |
| Frozen Food | 369 | 352 | 448 | 427 | 3 - 5 | -12 | -14 | -5 | -5 | 225 | 225 |
| Ice Cream | 422 | 403 | 481 | 459 | 3 - 5 | -22 | -22 | -13 | -13 | 225 | 225 |
| Medium Temp | 213 | 204 | 286 | 273 | 6 - 8 | 28 | 28 | 34 | 34 | 225 | 225 |

| DEFROST CONTROLS | | | | | | | | |
|------------------------|------------------|--------------------|------------------|-----------------------|-------------------|-----------------------|-----------------|-----------------------|
| Application | Defrosts Per Day | Run Off Time (Min) | Electric Defrost | | Timed-Off Defrost | | Hot Gas Defrost | |
| | | | Fail-Safe (Min) | Termination Temp (°F) | Fail-Safe (Min) | Termination Temp (°F) | Fail Safe (Min) | Termination Temp (°F) |
| Medium Temp | 1 | --- | 35 | 42 | 45 | 42 | 20 | 60 |
| Frozen Food/ Ice Cream | 1 | 13 - 15 | 35 | 52 | --- | --- | 20 | 60 |

NOTES

- “---” indicates the feature is not an option for this case model and/or the data is not yet available.
- Load data represents the sum of both coils.
- Listed evaporator temperature represents unlighted shelves.
- BTUH load increases by 132 BTUH/ft when aftermarket merchandising accessories are utilized.
- Listed discharge air velocity represents the average velocity at the peak of defrost.
- Temperature and defrost settings listed above are recommended start-up settings. Final operational settings may need to be adjusted for the store conditions in which the case operates.
- The recommended evaporator temperatures may need to be adjusted based on system setup, store conditions, etc.
- The minimum recommended evaporator temperature is 4°F below the listed evaporator temperature.
- Medium Temp application is run in dual temp mode only.
- Not intended for frozen juice application.





ALL MEASUREMENTS ARE TAKEN PER ASHRAE-72-2005 SPECIFICATIONS. HILLPHOENIX REFRIGERATED DISPLAY CASES FOR SALE IN THE UNITED STATES MEET OR EXCEED DEPARTMENT OF ENERGY 2017 REQUIREMENTS.

ONIZ

| Rev. Date | Rev. # | Rev. Title |
|-----------|--------|----------------|
| 9-14-20 | 4 | OPTIONS UPDATE |
| 4-9-20 | 3 | DATA UPDATE |

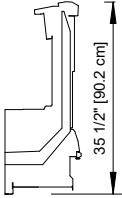
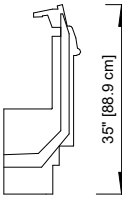
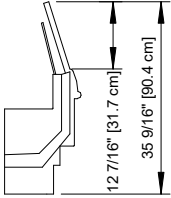
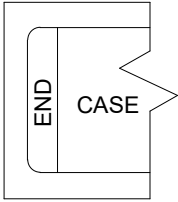
Hillphoenix
A DOVER COMPANY

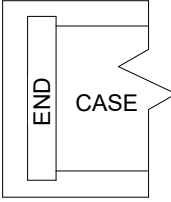
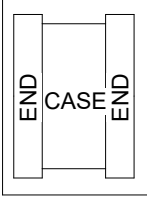
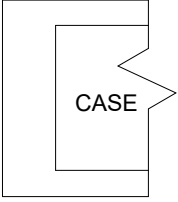
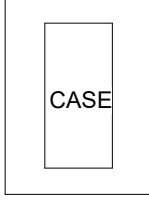
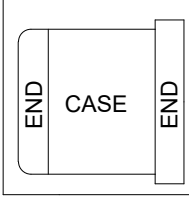
| FRONT OPTIONS | | | |
|---|---|---|--|
| <u>SOLID FRONT</u>  | <u>CLASSIC 2 FRONT</u>  | <u>THERMOPANE GLASS FRONT</u>  | |
| END OPTIONS | | | |
| <u>SINGLE WRAP END</u>  | <u>DOUBLE WRAP END</u>  | <u>SINGLE FLAT END</u>  | <u>DOUBLE FLAT END</u>  |
| <u>SINGLE JOINT (BUTT)</u>  | <u>DOUBLE JOINT (BUTT)</u>  | <u>SINGLE WRAP, SINGLE FLAT END</u>  | |



ALL MEASUREMENTS ARE TAKEN PER ASHRAE-72-2005 SPECIFICATIONS. HILLPHOENIX REFRIGERATED DISPLAY CASES FOR SALE IN THE UNITED STATES MEET OR EXCEED DEPARTMENT OF ENERGY 2017 REQUIREMENTS.

ONIZ

| Rev. Date | Rev. # | Rev. Title |
|-----------|--------|----------------|
| 9-14-20 | 4 | OPTIONS UPDATE |
| 4-9-20 | 3 | DATA UPDATE |

Hillphoenix
A DOVER COMPANY

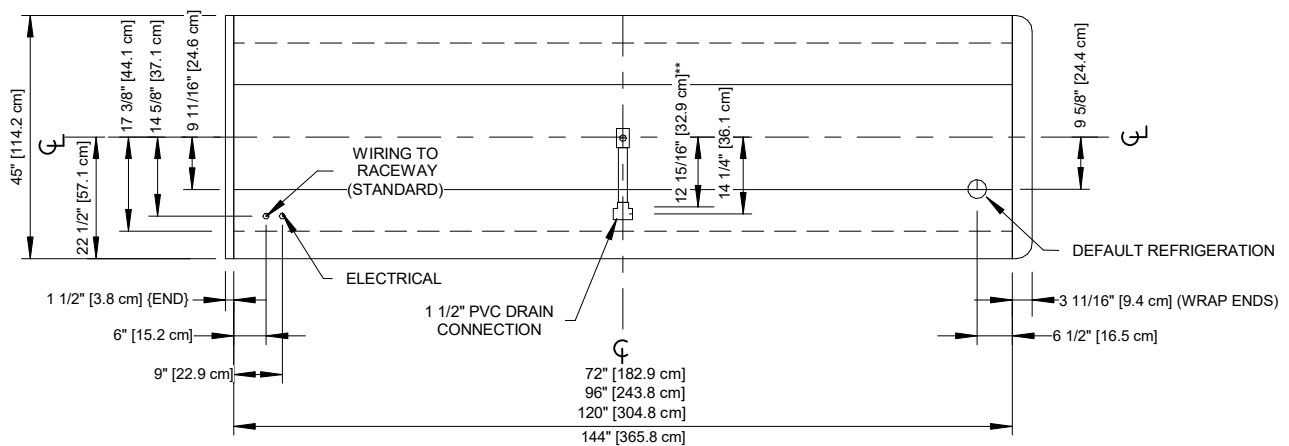
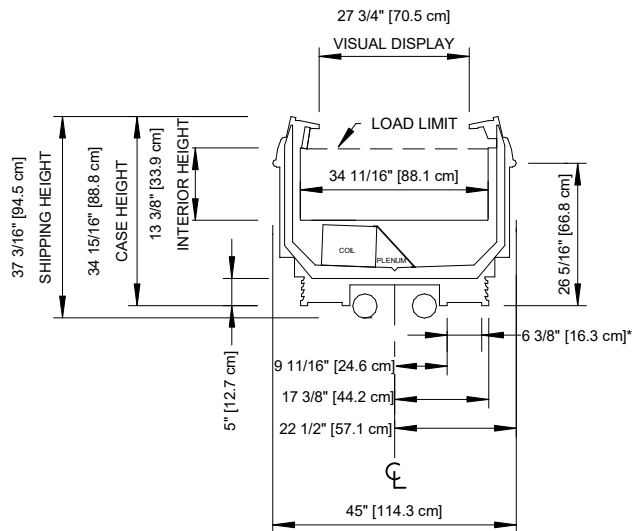

NOTES

- * :STUB-UP AREA
- ** :RECOMMENDED STUB-UP CENTERLINE FOR ELECTRICAL AND HUB DRAINS
- Front and rear sill heights vary with baseframe height.



ALL MEASUREMENTS ARE TAKEN PER ASHRAE-72-2005 SPECIFICATIONS. HILLPHOENIX REFRIGERATED DISPLAY CASES FOR SALE IN THE UNITED STATES MEET OR EXCEED DEPARTMENT OF ENERGY 2017 REQUIREMENTS.

ONIZ

| Rev. Date | Rev. # | Rev. Title |
|-----------|--------|----------------|
| 9-14-20 | 4 | OPTIONS UPDATE |
| 4-9-20 | 3 | DATA UPDATE |

Hillphoenix
A DOVER COMPANY