

Preserve Your Charge with ChargeSecure™

Designed exclusively for **Hillphoenix** CO₂ refrigeration systems, ChargeSecure™ preserves the charge in your CO₂ rack during power outages and service events, allowing you to get your refrigeration system back up and running more quickly when the power returns. By utilizing the CO₂ already in your system, ChargeSecure offers future-focused protection against costly recharging.

Features:

- Automatic operation requiring no manual intervention.
- Environmentally friendly because it uses natural CO₂ refrigerant to operate.
- Designed for seamless installation into existing systems in the field.
- Can be powered either by a backup generator or a Hillphoenix-supplied UPS battery module.

Benefits:

- Preserved Charge - by compressing and discharging the CO₂ gas into gas cooler.
- Uninterrupted Cooling - enabling immediate rack restart when power comes back on.
- Enhanced Reliability - that the refrigeration system will continue to function.
- Cost Savings - of expense of recharging your refrigeration system due to CO₂ loss during power outages or service events.
- Peace of Mind - that your refrigeration system charge is secure.



Retrofitting / Site Installation Unit:

- Wall or floor mount options
- Supplied with field retrofit kit:
 - Oil Solenoid Valves
 - Oil Filter
 - Orifice and Check Valves
 - Ball Valves
 - Wire Harnesses
 - 8mm Steel Pipe and Fittings
- Supplied with enclosure
- Supplied with mounting brackets
- Optional: Backup Battery & UPS
 - Backup Battery Run Time: Approximately 10-12 hours with one battery pack, depending on ambient conditions and store design. Option to add up to 3 battery packs.

PIPE SIZES AND TYPES

Oil Supply	8mm Steel Pipe
CO₂ Suction & Discharge	3/8" Copper Pipes

ELECTRICAL SPECIFICATIONS

AC Power Connection	208-230V / 1ph / 60Hz
MCA	6 Amps
MOPD	15 Amps

Dimensional Drawings

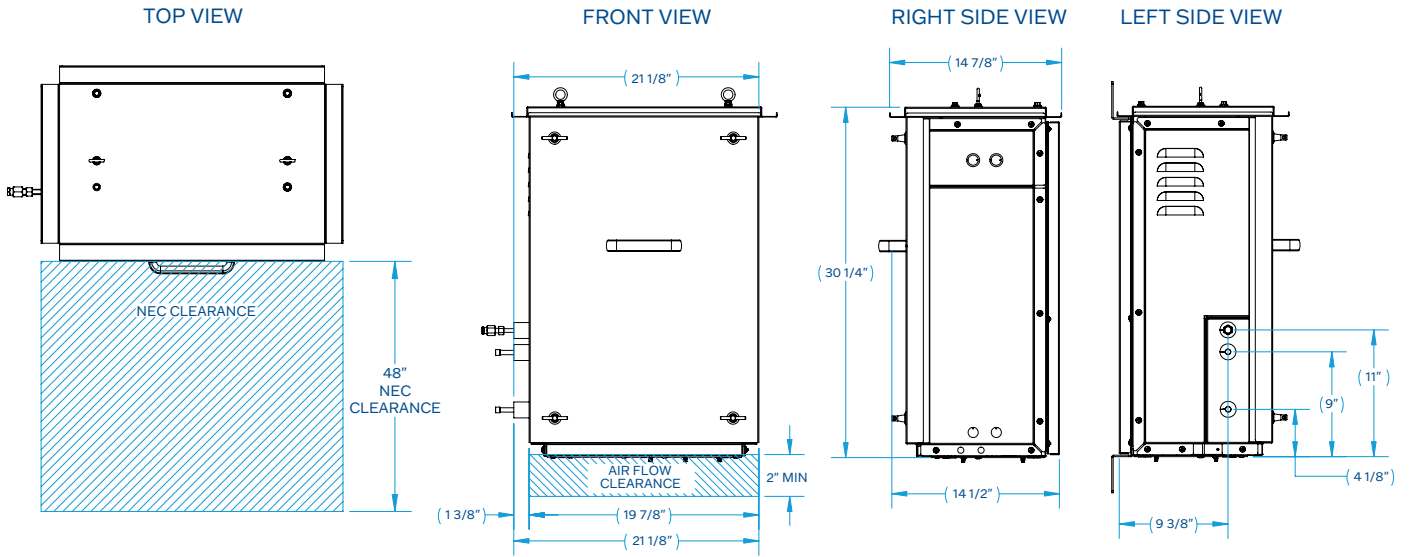

Mounting Options

FLOOR MOUNT

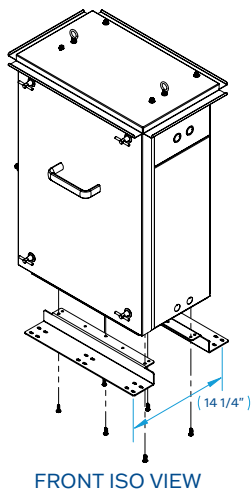
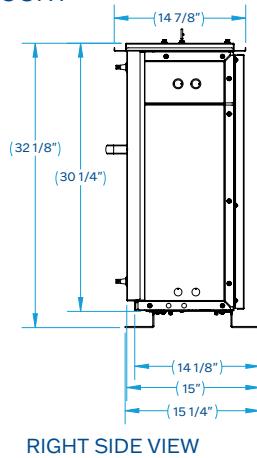

WALL MOUNT

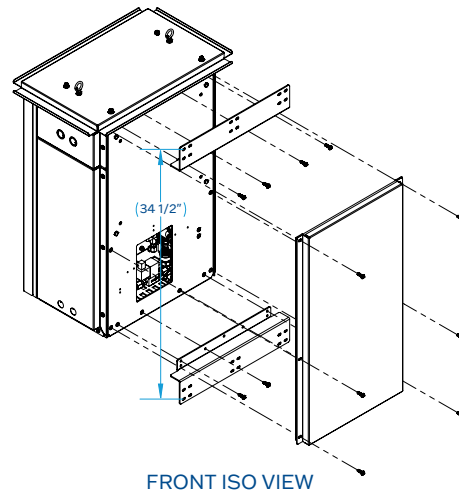
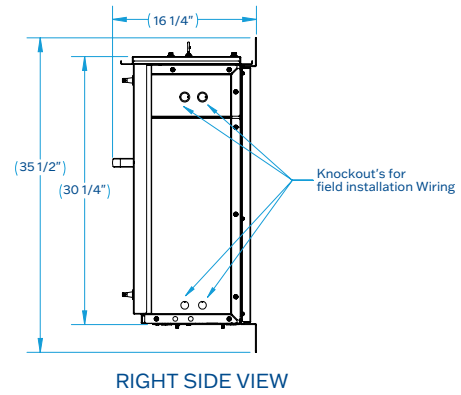

Hillphoenix.

Conyers, GA 30013
770-285-3264
hillphoenix.com

Scan the QR code or visit hillphoenix.com/chargeseecure to learn more about ChargeSecure.

