

O2.5UMQA-NRG

8' & 12' Multi-Deck Merchandiser with Synergy-E™
Bakery/Dairy/Cut Produce/Deli/Meat/Seafood

SOLOCHILL
MICRO-DISTRIBUTED

GENERAL NOTES:

- "---" indicates that the feature is not an option with this case model and/or the data is not available at this time.
- LED lights only.
- Maximum of 3 rows of standard output LED lighted shelves.
- Nose lights are not available.

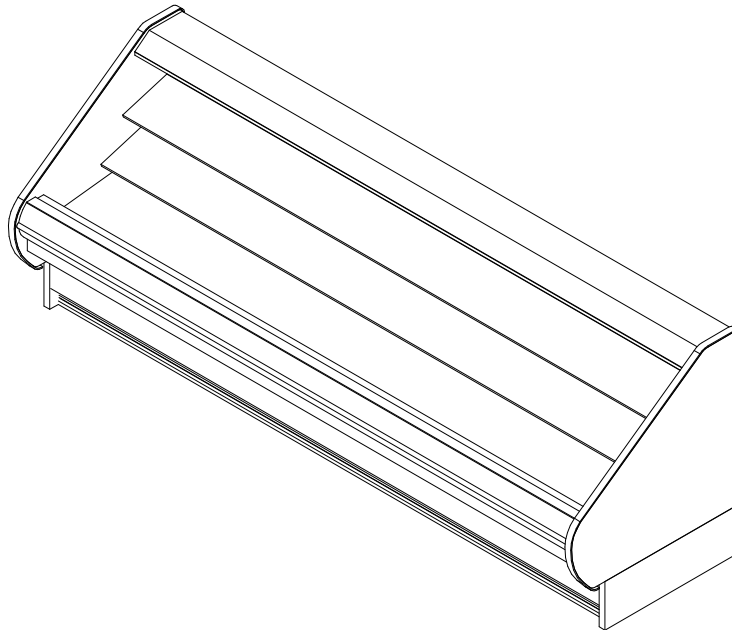

SHIPPING WEIGHT	
Case	Weight
O2.5UMQA-NRG	---



ALL MEASUREMENTS ARE TAKEN PER ASHRAE-72-2005 SPECIFICATIONS. HILLPHOENIX REFRIGERATED DISPLAY CASES FOR SALE IN THE UNITED STATES MEET OR EXCEED DEPARTMENT OF ENERGY 2017 REQUIREMENTS.

O2.5UMQA-NRG

Rev. Date	Rev. #	Rev. Title
9-30-20	2	SOLOCHILL V5
9-18-19	1	SOLOCHILL V4

Hillphoenix
A DOVER COMPANY

O2.5UMQA-NRG

8' & 12' Multi-Deck Merchandiser with Synergy-E™
Bakery/Dairy/Cut Produce/Deli/Meat/Seafood



ELECTRICAL DATA			
Case Length	Fans Per Case	High Efficiency Fans	
		120 Volt	
		Amps	Watts
8'	2	0.32	22
12'	3	0.48	33

LIGHTING DATA					
Case Length	Lights per row	Clearvoyant v4 LED Lighting (Per Light Row)			
		Standard Power (Cornice or Shelf)		High Power (Cornice Only)	
		120 Volts		120 Volts	
		Amps	Watts	Amps	Watts
8'	2	0.10	11.8	0.25	29.8
12'	3	0.15	17.7	0.37	44.7

DEFROST CONTROLS		
Defrosts Per Day	Timed-Off Defrost	
	Fail-Safe (Min)	Termination Temp (F)
6	30	47

NOTES:

- "--" indicates that the feature is not an option with this case model and/or the data is not available at this time.
- Listed discharge air velocity represents the average velocity at the peak of defrost.
- Temperature and defrost settings listed above are recommended start-up settings. Final operational settings may need to be adjusted for the store conditions in which the case operates.



ALL MEASUREMENTS ARE TAKEN PER ASHRAE-72-2005 SPECIFICATIONS. HILLPHOENIX REFRIGERATED DISPLAY CASES FOR SALE IN THE UNITED STATES MEET OR EXCEED DEPARTMENT OF ENERGY 2017 REQUIREMENTS.

O2.5UMQA-NRG

Rev. Date	Rev. #	Rev. Title
9-30-20	2	SOLOCHILL V5
9-18-19	1	SOLOCHILL V4



A DOVER COMPANY

O2.5UMQA-NRG

8' & 12' Multi-Deck Merchandiser with Synergy-E™
Bakery/Dairy/Cut Produce/Deli/Meat/Seafood



SOLOCHILL DATA			@95° Condensing Temperature		
Volts	Phase	Frequency	Wire		
208	1	60	3 Wire + Ground		
Application		Case Length	Evaporator Temp (°F)	Discharge Air (°F)	Discharge Air Velocity (FPM)
Bakery/Dairy/Cut Produce/Deli		8'	26	31	180
Bakery/Dairy/Cut Produce/Deli		12'	26	31	180
Meat/Seafood		8'	24	30	180
Meat/Seafood		12'	24	30	180

Application	Case Length	R448A					
		Condensing Unit Model	MCA	MOP	Required Capacity	THR (BTUH)	Flow Rate
Bakery/Dairy/Cut Produce/Deli	8'	DA130	11.7	15	7008	8748	2.5
Bakery/Dairy/Cut Produce/Deli	12'	DA220	18.6	20	10512	12846	3.7
Meat/Seafood	8'	DA130	11.7	15	6920	8820	2.5
Meat/Seafood	12'	DA220	18.6	20	10380	12938	3.7

NOTES:

* SoloChill CDU is remote mount only.



ALL MEASUREMENTS ARE TAKEN PER ASHRAE-72-2005 SPECIFICATIONS. HILLPHOENIX REFRIGERATED DISPLAY CASES FOR SALE IN THE UNITED STATES MEET OR EXCEED DEPARTMENT OF ENERGY 2017 REQUIREMENTS.

O2.5UMQA-NRG

Rev. Date	Rev. #	Rev. Title
9-30-20	2	SOLOCHILL V5
9-18-19	1	SOLOCHILL V4







A DOVER COMPANY

O2.5UMQA-NRG

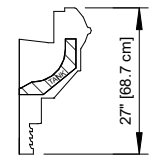
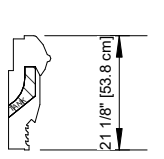
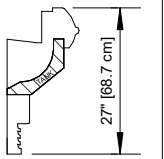
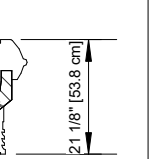
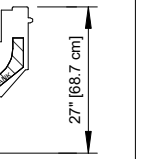
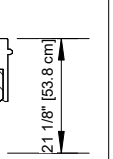
8' & 12' Multi-Deck Merchandiser with Synergy-E™
Bakery/Dairy/Cut Produce/Deli/Meat/Seafood

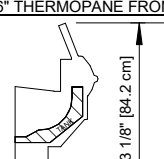
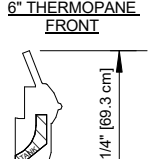
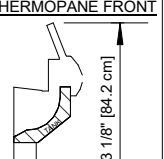
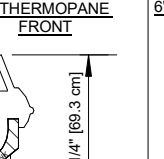
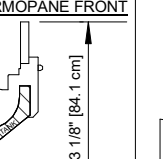
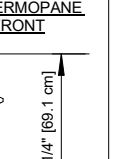
SOLOCHILL
MICRO-DISTRIBUTED

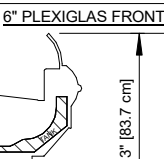
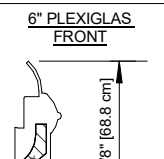
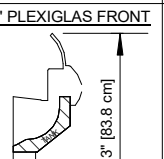
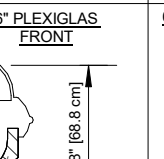
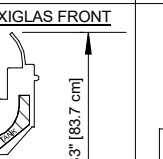
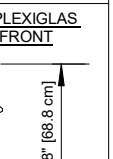
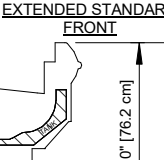
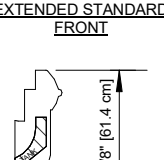
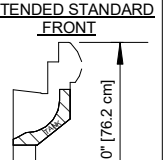
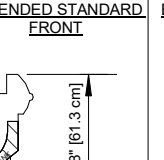
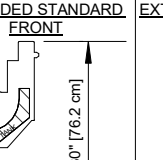
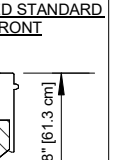
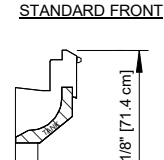
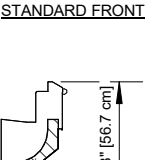
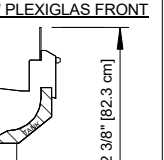
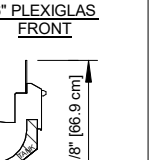
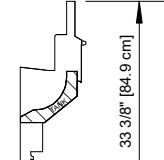
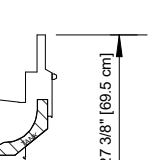
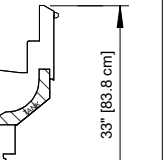
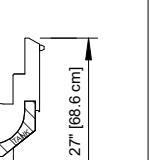
REAR SILL OPTIONS	FRONT OPTIONS					
	ORIGIN 2 FRONT				FLAT FRONT FLAT TOP	
	STANDARD FRONT	STANDARD FRONT	STANDARD FRONT	STANDARD FRONT	STANDARD FRONT	STANDARD FRONT
STANDARD REAR SILL  8 1/2" [21.7 cm]						
12 1/2" REAR SILL  12 1/2" [31.7 cm]						
16" REAR SILL (REAR DISCHARGE)  16" [40.7 cm]						
						
	FLAT FRONT ANGLED TOP					
						
						



COMPONENT

ALL MEASUREMENTS ARE TAKEN PER ASHRAE-72-2005 SPECIFICATIONS. HILLPHOENIX REFRIGERATED DISPLAY CASES FOR SALE IN THE UNITED STATES MEET OR EXCEED DEPARTMENT OF ENERGY 2017 REQUIREMENTS.

O2.5UMQA-NRG

Rev. Date	Rev. #	Rev. Title
9-30-20	2	SOLOCHILL V5
9-18-19	1	SOLOCHILL V4

Hillphoenix
A DOVER COMPANY

O2.5UMQA-NRG

8' & 12' Multi-Deck Merchandiser with Synergy-E™
Bakery/Dairy/Cut Produce/Deli/Meat/Seafood

SOLOCHILL
MICRO-DISTRIBUTED

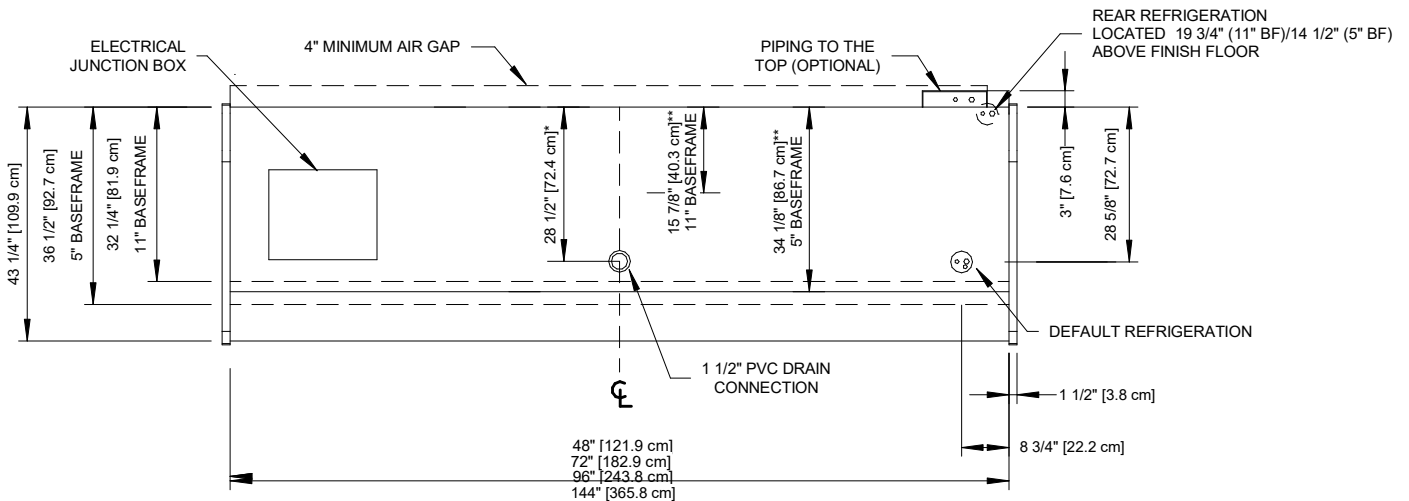
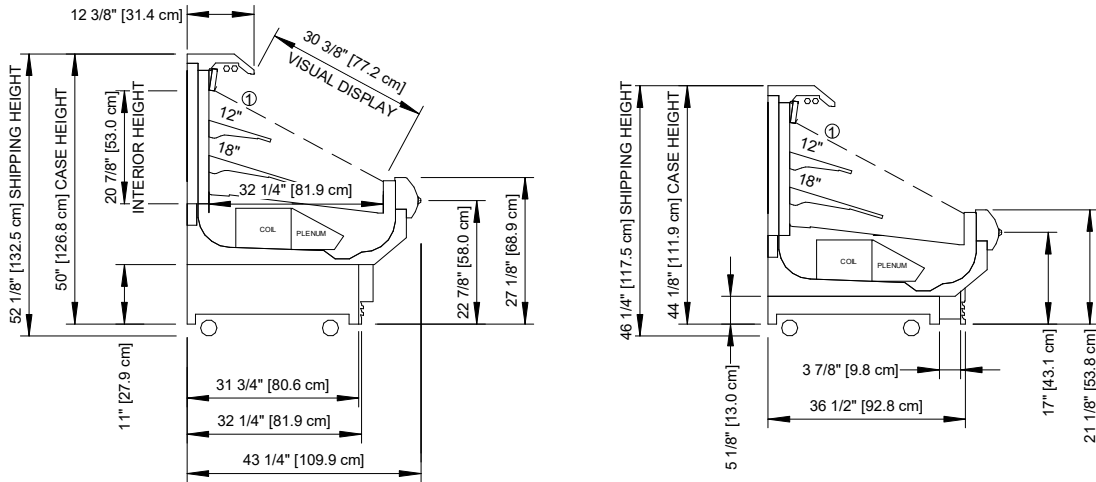

NOTES:

- * :STUB-UP AREA
- ** :RECOMMENDED STUB-UP CENTERLINE FOR ELECTRICAL AND HUB DRAINS
- Ⓛ :AVAILABLE SHELF SIZES ARE 10", 12", 14", 16", & 18"

- Ends add approximately 1 inch to case height, 1 inch to the front and 1/2 inch to the back.
- Product on top shelf should be 3 inches below discharge.



ALL MEASUREMENTS ARE TAKEN PER ASHRAE-72-2005 SPECIFICATIONS. HILLPHOENIX REFRIGERATED DISPLAY CASES FOR SALE IN THE UNITED STATES MEET OR EXCEED DEPARTMENT OF ENERGY 2017 REQUIREMENTS.

O2.5UMQA-NRG

Rev. Date	Rev. #	Rev. Title
9-30-20	2	SOLOCHILL V5
9-18-19	1	SOLOCHILL V4

Hillphoenix
A DOVER COMPANY