

O3UMQA-NRG

8' & 12' Multi-Deck Merchandiser with Synerg-E™
Dairy/Deli/Meat/Produce

SOLOCHILL
MICRO-DISTRIBUTED

GENERAL NOTES:

- "---" indicates that the feature is not an option for this case model and/or the data is not yet available.
- LED lights only.
- Maximum of 2 rows of standard output LED lighted shelves.
- Nose lights are not available.

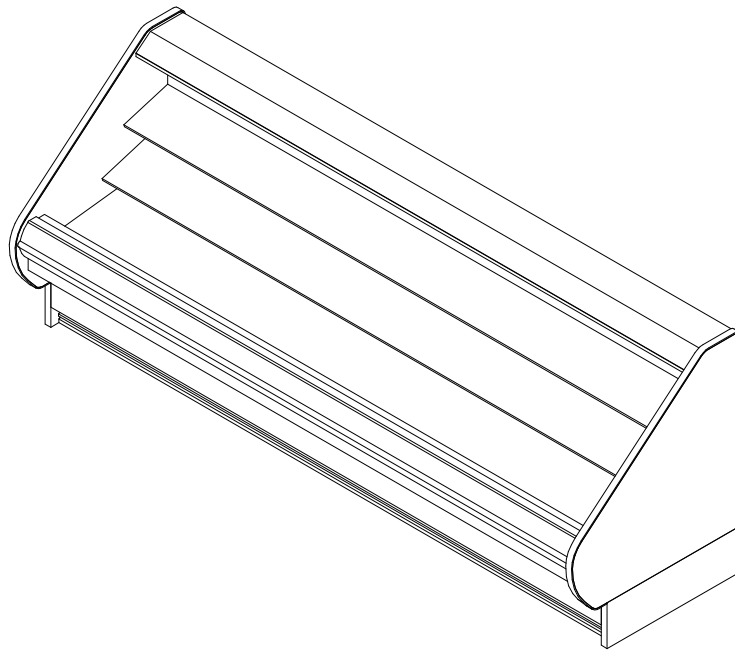

SHIPPING WEIGHT	
Case	Weight
O3UMQA-NRG	---



ALL MEASUREMENTS ARE TAKEN PER ASHRAE-72-2005 SPECIFICATIONS. HILLPHOENIX REFRIGERATED DISPLAY CASES FOR SALE IN THE UNITED STATES MEET OR EXCEED DEPARTMENT OF ENERGY 2017 REQUIREMENTS.

O3UMQA-NRG

Rev. Date	Rev. #	Rev. Title
9-30-20	2	SOLOCHILL V5
9-18-19	1	SOLOCHILL V4

Hillphoenix
A DOVER COMPANY

O3UMQA-NRG

8' & 12' Multi-Deck Merchandiser with Synerg-E™
Dairy/Deli/Meat/Produce



ELECTRICAL DATA			
Case Length	Fans Per Case	High Efficiency Fans	
		120 Volts	
		Amps	Watts
8'	2	0.32	22.0
12'	3	0.48	33.0

LIGHTING DATA						
Case Length	Lights per row	Lights Length	Clearvoyant LED Lighting (Per Light Row)			
			Standard Power (Cornice or Shelf)		High Power (Cornice)	
			120 Volts		120 Volts	
			Amps	Watts	Amps	Watts
8'	2	4'	0.10	11.8	0.25	29.9
12'	3	4'	0.15	17.6	0.37	44.8

DEFROST CONTROLS		
Defrosts Per Day	Timed-Off Defrost	
	Fail-Safe (Min)	Termination Temp (°F)
6	30	47

NOTES:

- "—" indicates that the feature is not an option for this case model and/or the data is not yet available.
- Listed discharge air velocity represents the average velocity immediately after defrost.
- Temperature and defrost settings listed above are recommended start-up settings. Final operational settings may need to be adjusted for the store conditions in which the case operates.



ALL MEASUREMENTS ARE TAKEN PER ASHRAE-72-2005 SPECIFICATIONS. HILLPHOENIX REFRIGERATED DISPLAY CASES FOR SALE IN THE UNITED STATES MEET OR EXCEED DEPARTMENT OF ENERGY 2017 REQUIREMENTS.

O3UMQA-NRG

Rev. Date	Rev. #	Rev. Title
9-30-20	2	SOLOCHILL V5
9-18-19	1	SOLOCHILL V4



A DOVER COMPANY

O3UMQA-NRG

8' & 12' Multi-Deck Merchandiser with Synerg-E™
Dairy/Deli/Meat/Produce



SOLOCHILL DATA			@95° Condensing Temperature		
Volts	Phase	Frequency	Wire		
208	1	60	3 Wire + Ground		
Application		Case Length	Evaporator Temp (°F)	Discharge Air (°F)	Discharge Air Velocity (FPM)
DAIRY/DELI/CUT PRODUCE		8'	26	31	180
DAIRY/DELI/CUT PRODUCE		12'	26	31	180
MEAT EXT FRONT		8'	24	30	180
MEAT EXT FRONT		12'	24	30	180

Application	Case Length	R448A					
		Condensing Unit Model	MCA	MOP	Required Capacity	THR (BTUH)	Flow Rate
DAIRY/DELI/CUT PRODUCE	8'	DA130	11.7	15	6784	8470	2.4
DAIRY/DELI/CUT PRODUCE	12'	DA220	18.6	20	10176	12439	3.6
MEAT EXT FRONT	8'	DA130	11.7	15	6784	8539	2.4
MEAT EXT FRONT	12'	DA220	18.6	20	10176	12528	3.6

NOTES:

* SoloChill CDU is remote mount only.



ALL MEASUREMENTS ARE TAKEN PER ASHRAE-72-2005 SPECIFICATIONS. HILLPHOENIX REFRIGERATED DISPLAY CASES FOR SALE IN THE UNITED STATES MEET OR EXCEED DEPARTMENT OF ENERGY 2017 REQUIREMENTS.

O3UMQA-NRG

Rev. Date	Rev. #	Rev. Title
9-30-20	2	SOLOCHILL V5
9-18-19	1	SOLOCHILL V4



A DOVER COMPANY





O3UMQA-NRG

8' & 12' Multi-Deck Merchandiser with Synerg-E™
Dairy/Deli/Meat/Produce

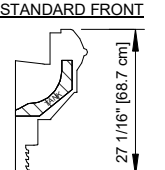
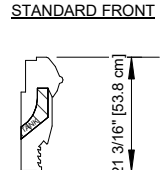
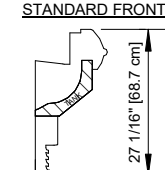
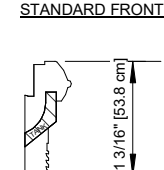
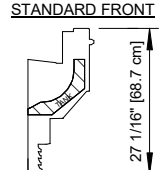
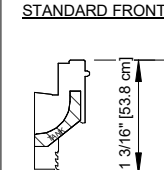

NOTES:

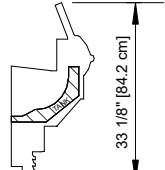
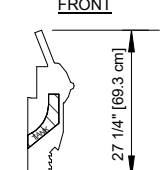
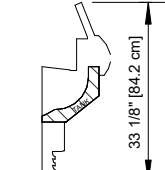
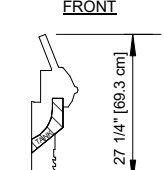
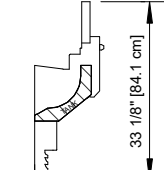
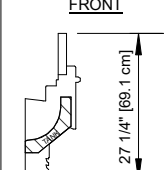
- Front and rear sill heights vary with base frame height.
- Extended front sills are required for meat applications to maintain proper product temperature. An extended front has a minimum height of 24" on a 5" baseframe, or 30" on an 11" baseframe.

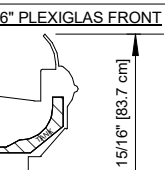
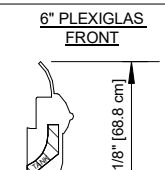
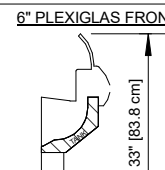
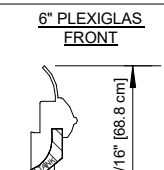
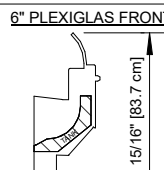
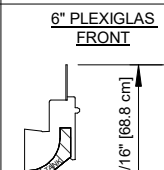
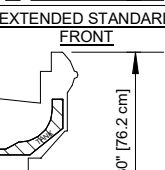
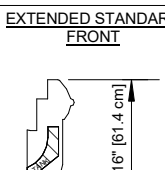
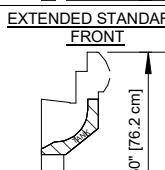
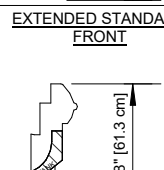
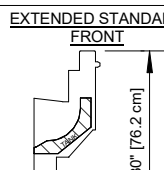
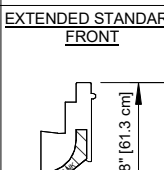
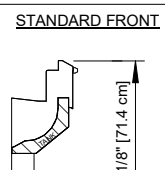
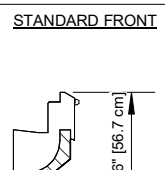
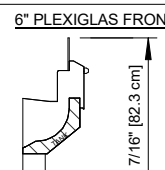
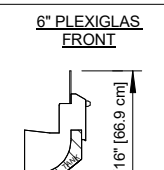
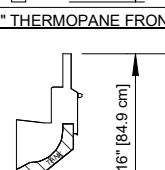
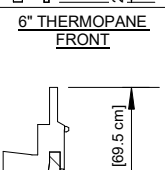
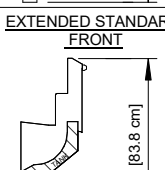
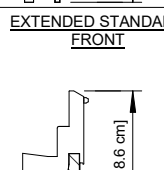
REAR SILL OPTIONS	FRONT OPTIONS					
	ORIGIN 2 FRONT				FLAT FRONT FLAT TOP	
STANDARD REAR SILL 8 9/16" [21.7 cm] 	STANDARD FRONT  27 1/16" [68.7 cm]	STANDARD FRONT  21 3/16" [53.8 cm]	STANDARD FRONT  27 1/16" [68.7 cm]	STANDARD FRONT  21 3/16" [53.8 cm]	STANDARD FRONT  27 1/16" [68.7 cm]	STANDARD FRONT  21 3/16" [53.8 cm]
12 1/2" REAR SILL 12 7/16" [31.7 cm] 	6" THERMOPANE FRONT  33 1/8" [84.2 cm]	6" THERMOPANE FRONT  27 1/4" [69.3 cm]	6" THERMOPANE FRONT  33 1/8" [84.2 cm]	6" THERMOPANE FRONT  27 1/4" [69.3 cm]	6" THERMOPANE FRONT  33 1/8" [84.1 cm]	6" THERMOPANE FRONT  27 1/4" [69.1 cm]
16" REAR SILL (REAR DISCHARGE) 16 1/16" [40.7 cm] 	6" PLEXIGLAS FRONT  32 15/16" [83.7 cm]	6" PLEXIGLAS FRONT  27 1/8" [68.8 cm]	6" PLEXIGLAS FRONT  33" [83.8 cm]	6" PLEXIGLAS FRONT  27 1/16" [68.8 cm]	6" PLEXIGLAS FRONT  32 15/16" [83.7 cm]	6" PLEXIGLAS FRONT  27 1/16" [68.8 cm]
	EXTENDED STANDARD FRONT  30" [76.2 cm]	EXTENDED STANDARD FRONT  24 3/16" [61.4 cm]	EXTENDED STANDARD FRONT  30" [76.2 cm]	EXTENDED STANDARD FRONT  24 1/8" [61.3 cm]	EXTENDED STANDARD FRONT  30" [76.2 cm]	EXTENDED STANDARD FRONT  24 1/8" [61.3 cm]
	FLAT FRONT ANGLED TOP					
	STANDARD FRONT  28 1/8" [71.4 cm]	STANDARD FRONT  22 5/16" [56.7 cm]	6" PLEXIGLAS FRONT  32 7/16" [82.3 cm]	6" PLEXIGLAS FRONT  26 5/16" [66.9 cm]		
	6" THERMOPANE FRONT  33 7/16" [84.9 cm]	6" THERMOPANE FRONT  27 3/8" [69.5 cm]	EXTENDED STANDARD FRONT  33" [83.8 cm]	EXTENDED STANDARD FRONT  27" [68.6 cm]		



ALL MEASUREMENTS ARE TAKEN PER ASHRAE-72-2005 SPECIFICATIONS. HILLPHOENIX REFRIGERATED DISPLAY CASES FOR SALE IN THE UNITED STATES MEET OR EXCEED DEPARTMENT OF ENERGY 2017 REQUIREMENTS.

O3UMQA-NRG

Rev. Date	Rev. #	Rev. Title
9-30-20	2	SOLOCHILL V5
9-18-19	1	SOLOCHILL V4



A DOVER COMPANY

O3UMQA-NRG

8' & 12' Multi-Deck Merchandiser with Synerg-E™
Dairy/Deli/Meat/Produce

SOLOCHILL
MICRO-DISTRIBUTED

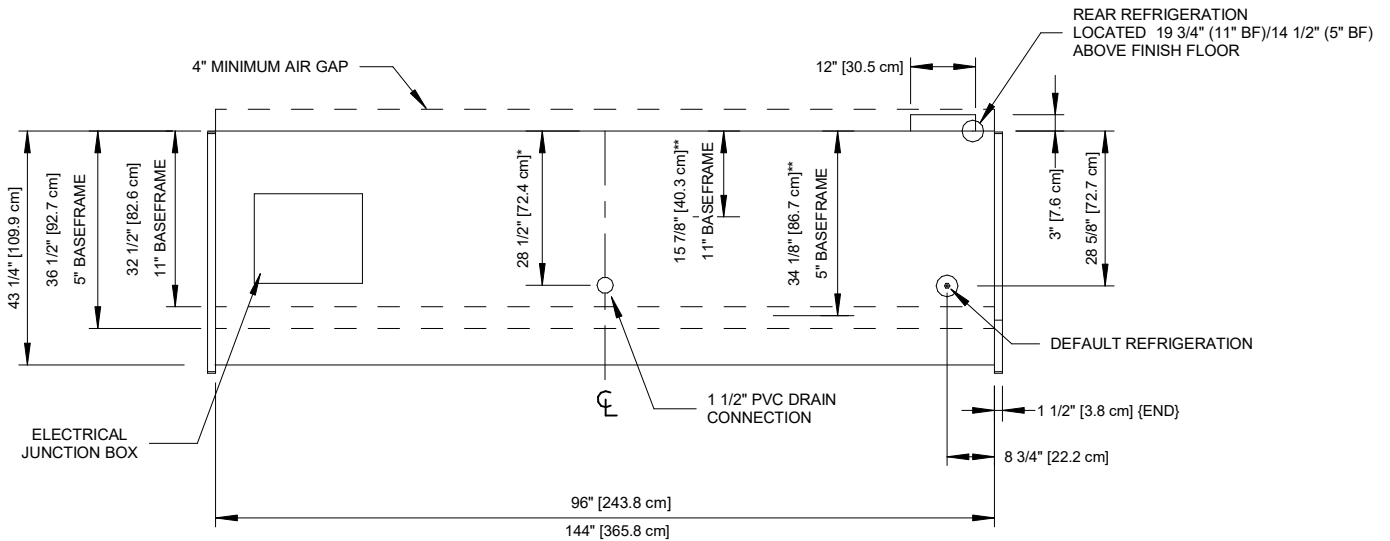
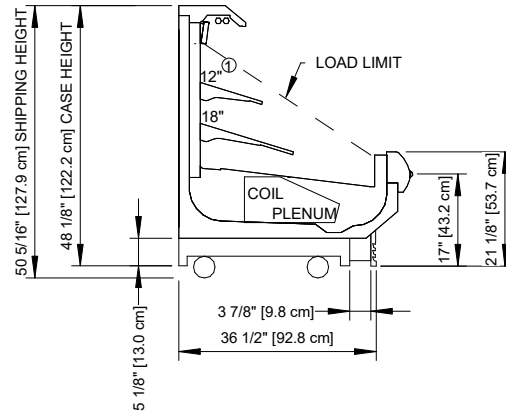
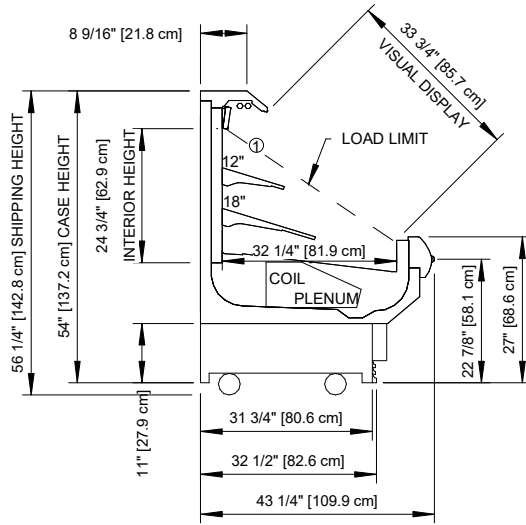

NOTES:

- * :STUB-UP AREA
- ** :RECOMMENDED STUB-UP CENTERLINE FOR ELECTRICAL AND HUB DRAINS
- ① :AVAILABLE SHELF SIZES: 10", 12", 14", 16", & 18"

• Ends add approximately 1" to case height, 1" to the front and 1/2" to the back.



ALL MEASUREMENTS ARE TAKEN PER ASHRAE-72-2005 SPECIFICATIONS. HILLPHOENIX REFRIGERATED DISPLAY CASES FOR SALE IN THE UNITED STATES MEET OR EXCEED DEPARTMENT OF ENERGY 2017 REQUIREMENTS.

O3UMQA-NRG

Rev. Date	Rev. #	Rev. Title
9-30-20	2	SOLOCHILL V5
9-18-19	1	SOLOCHILL V4

Hillphoenix
A DOVER COMPANY