

O5DMH-NRG

4', 6', 8' & 12' High Multi-Deck Merchandiser with Synerg-E™
Beverage / Bakery / Dairy / Cut Produce / Deli

GENERAL NOTES:

- "---" indicates that the feature is not an option on this case model and/or the data is not available at this time.
- LED lights only.
- Maximum of 5 rows of Standard Output LED lighted shelves.

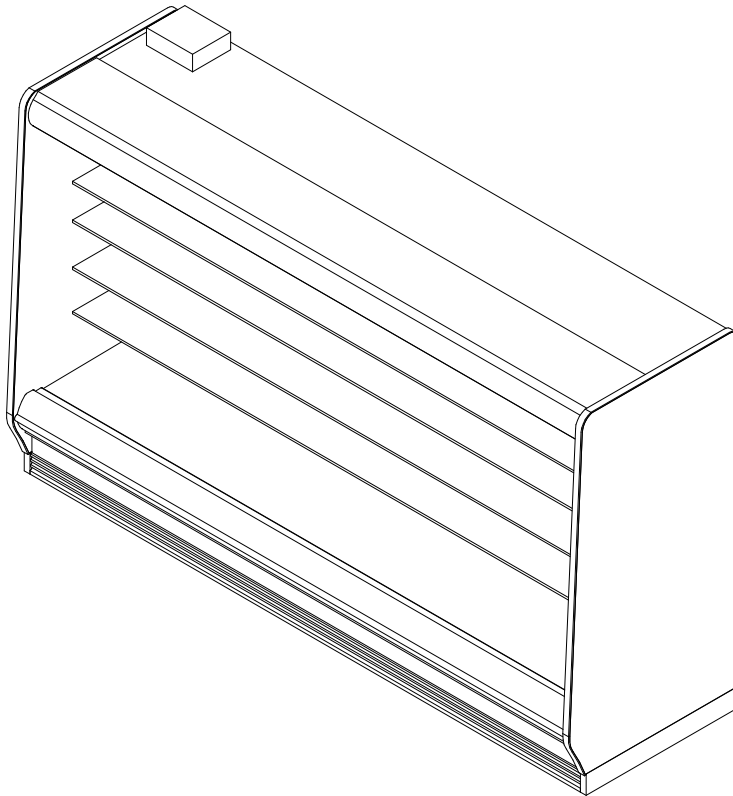

SHIPPING WEIGHT	
Case	Weight
O5DMH-NRG	---



ALL MEASUREMENTS ARE TAKEN PER ASHRAE-72 SPECIFICATIONS. HILLPHOENIX REFRIGERATED DISPLAY CASES FOR SALE IN THE UNITED STATES MEET OR EXCEED DEPARTMENT OF ENERGY 2017 REQUIREMENTS.

O5DMH-NRG

Rev. Date	Rev. #	Rev. Title
12-09-21	9	OPTION PAGE UPDATE
07-15-21	8	ENDVIEW UPDATE



O5DMH-NRG

4', 6', 8' & 12' High Multi-Deck Merchandiser with Synerg-E™
Beverage / Bakery / Dairy / Cut Produce / Deli

ELECTRICAL DATA			
Case Length	Fans Per Case	High Efficiency Fans	
		120 Volt	
		Amps	Watts
4'	1	0.23	18.0
6'	2	0.47	35.0
8'	2	0.47	35.0
12'	3	0.70	53.0

LIGHTING DATA					
Case Length	Lights per row	Clearvoyant v4 LED Lighting (Per Light Row)			
		Standard Power (Cornice or Shelf)		High Power (Cornice Only)	
		120 Volts		120 Volts	
		Amps	Watts	Amps	Watts
4'	1	0.05	5.9	0.12	14.9
8'	2	0.08	9.4	0.20	23.8
6'	2	0.10	11.8	0.25	29.9
12'	3	0.15	17.6	0.37	44.8

GUIDELINES AND CONTROL SETTINGS							
Application	Front Sill height	BTUH/ft		Superheat Set Point @ Bulb (°F)	Evaporator (°F)	Discharge Air (°F)	Discharge Air Velocity (FPM)
		Conventional	Parallel				
Beverage/Bulk Produce	2.5" Extended	1291	1130	6 - 8	34	37	150
Beverage/Bulk Produce	5" Extended	1263	1105	6 - 8	34	37	150
Beverage/Bulk Produce	7.5" Extended	1240	1085	6 - 8	34	37	150
Beverage/Bulk Produce	Standard	1331	1165	6 - 8	34	37	150
Dairy/Deli/Cut Produce	2.5" Extended	1531	1340	6 - 8	28	31	150
Dairy/Deli/Cut Produce	5" Extended	1503	1315	6 - 8	28	31	150
Dairy/Deli/Cut Produce	7.5" Extended	1480	1295	6 - 8	28	31	150
Dairy/Deli/Cut Produce	Standard	1571	1375	6 - 8	28	31	150

DEFROST CONTROLS			
Application	Defrosts Per Day	Timed-Off Defrost	
		Fail-Safe (Min)	Termination Temp (F)
Beverage/Bulk Produce	2	30	47
Dairy/Deli/Cut Produce	6	40	47

NOTES:

- "----" indicates that the feature is not an option on this case model and/or the data is not available at this time.
- Listed BTUH/ft data represent unlighted shelves. For LED lighting, add 9 BTUH/ft per row of lighted shelving.
- BTUH load increases by 132 BTUH/ft when aftermarket merchandising accessories are utilized.
- Listed evaporator temperature represents unlighted shelves. For lighted shelves and/or aftermarket merchandising accessories, reduce the listed evaporator temperature by 2°F.
- Conventional Discharge Air Control – Recommended Settings: Cut-In Temp = Discharge Air + 2°F; Cut-Out Temp = Discharge Air - 2°F.
- Listed discharge air velocity represents the average velocity immediately after defrost.
- Temperature and defrost settings listed above are recommended start-up settings. Final operational settings may need to be adjusted for the store conditions in which the case operates.
- The recommended evaporator temperatures may need to be adjusted based on system setup, store conditions, etc. The minimum recommended evaporator temperature is 4°F below the listed evaporator temperature.



O5DMH-NRG

ALL MEASUREMENTS ARE TAKEN PER ASHRAE-72 SPECIFICATIONS. HILLPHOENIX REFRIGERATED DISPLAY CASES FOR SALE IN THE UNITED STATES MEET OR EXCEED DEPARTMENT OF ENERGY 2017 REQUIREMENTS.

Rev. Date	Rev. #	Rev. Title
12-09-21	9	OPTION PAGE UPDATE
07-15-21	8	ENDVIEW UPDATE

Hillphoenix
A DOVER COMPANY

O5DMH-NRG

4', 6', 8' & 12' High Multi-Deck Merchandiser with Synerg-E™
Beverage / Bakery / Dairy / Cut Produce / Deli

SECOND NATURE DATA

Case Model	No. of Coils	Application	Front Sill height	BTUH/FT		GPM/ft (DR)	Supply Fluid Temp (°F)	Discharge Air Temp (°F)
				Conventional	Parallel			
O5DMH-NRG	1	Beverage/Bulk Produce	7.5" Extended	1240	1085	0.24	20	37
O5DMH-NRG	1	Beverage/Bulk Produce	5" Extended	1263	1105	0.25	20	37
O5DMH-NRG	1	Beverage/Bulk Produce	2.5" Extended	1291	1130	0.25	20	37
O5DMH-NRG	1	Beverage/Bulk Produce	Standard	1331	1165	0.26	20	37
O5DMH-NRG	1	Deli	7.5" Extended	1480	1295	0.38	20	33
O5DMH-NRG	1	Deli	5" Extended	1503	1315	0.39	20	33
O5DMH-NRG	1	Deli	2.5" Extended	1531	1340	0.39	20	33
O5DMH-NRG	1	Deli	Standard	1571	1375	0.40	20	33
O5DMH-NRG	1	Beverage/Bulk Produce	7.5" Extended	1240	1085	0.42	25	37
O5DMH-NRG	1	Beverage/Bulk Produce	5" Extended	1263	1105	0.42	25	37
O5DMH-NRG	1	Beverage/Bulk Produce	2.5" Extended	1291	1130	0.43	25	37
O5DMH-NRG	1	Beverage/Bulk Produce	Standard	1331	1165	0.44	25	37
O5DMH-NRG	1	Deli	7.5" Extended	1480	1295	0.69	25	33
O5DMH-NRG	1	Deli	5" Extended	1503	1315	0.70	25	33
O5DMH-NRG	1	Deli	2.5" Extended	1531	1340	0.71	25	33
O5DMH-NRG	1	Deli	Standard	1571	1375	0.73	25	33

SECOND NATURE DATA

Case Model	No. of Coils	Application	Front Sill height	Supply Fluid Temp (°F)	No. of Defrost	Timed-Off Defrost		Warm Fluid Defrost	
						Fail-Safe (Min)	Termination Temp (°F)	Fail-Safe (Min)	Termination Temp (°F)
O5DMH-NRG	1	Beverage/Bulk Produce	7.5" Extended	20	6	60	47	26	49
O5DMH-NRG	1	Beverage/Bulk Produce	5" Extended	20	6	60	47	26	49
O5DMH-NRG	1	Beverage/Bulk Produce	2.5" Extended	20	6	60	47	26	49
O5DMH-NRG	1	Beverage/Bulk Produce	Standard	20	6	60	47	26	49
O5DMH-NRG	1	Deli	7.5" Extended	20	6	60	47	26	49
O5DMH-NRG	1	Deli	5" Extended	20	6	60	47	26	49
O5DMH-NRG	1	Deli	2.5" Extended	20	6	60	47	26	49
O5DMH-NRG	1	Deli	Standard	20	6	60	47	26	49
O5DMH-NRG	1	Beverage/Bulk Produce	7.5" Extended	25	6	45	47	26	49
O5DMH-NRG	1	Beverage/Bulk Produce	5" Extended	25	6	45	47	26	49
O5DMH-NRG	1	Beverage/Bulk Produce	2.5" Extended	25	6	45	47	26	49
O5DMH-NRG	1	Beverage/Bulk Produce	Standard	25	6	45	47	26	49
O5DMH-NRG	1	Deli	7.5" Extended	25	6	45	47	26	49
O5DMH-NRG	1	Deli	5" Extended	25	6	45	47	26	49
O5DMH-NRG	1	Deli	2.5" Extended	25	6	45	47	26	49
O5DMH-NRG	1	Deli	Standard	25	6	45	47	26	49

NOTES:

- All medium temperature data listed is for 35% by wt. PROPYLENE GLYCOL.
- Inhibited Propylene Glycol solution with water, such as Dowfrost or equivalent. (Dowfrost is a trademark of the Dow Chemical Company).
- Flowrates are determined by ASHRAE test conditions and may need to be adjusted based on store conditions.
- ** Flowrates are per case



O5DMH-NRG



ALL MEASUREMENTS ARE TAKEN PER ASHRAE-72 SPECIFICATIONS. HILLPHOENIX REFRIGERATED DISPLAY CASES FOR SALE IN THE UNITED STATES MEET OR EXCEED DEPARTMENT OF ENERGY 2017 REQUIREMENTS.

Rev. Date	Rev. #	Rev. Title
12-09-21	9	OPTION PAGE UPDATE
07-15-21	8	ENDVIEW UPDATE

Hillphoenix
A DOVER COMPANY

O5DMH-NRG

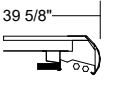
4', 6', 8' & 12' High Multi-Deck Merchandiser with Synerg-E™
Beverage / Bakery / Dairy / Cut Produce / Deli

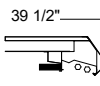
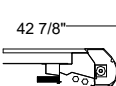
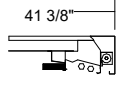
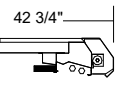
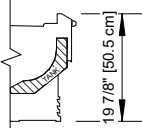
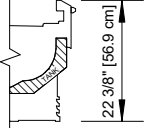
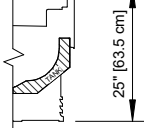
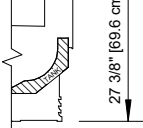
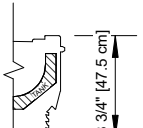
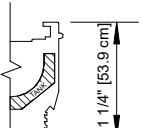
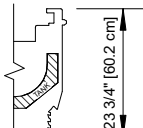
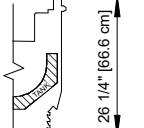
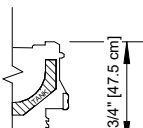
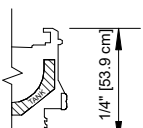
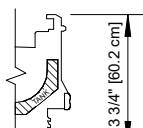
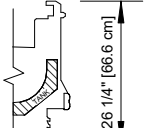
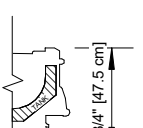
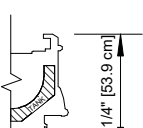
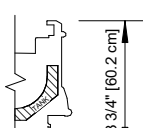
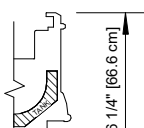
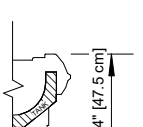
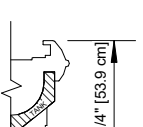
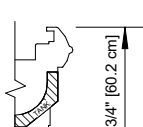
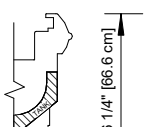
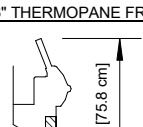
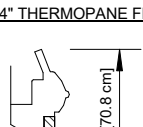
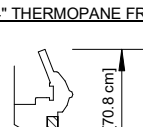
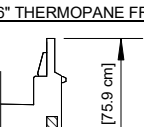
CORNICHE OPTIONS		CURVED CORNICE	FLAT CORNICE	FACETED CORNICE	CURVED CORNICE WITH NIGHT COVER	FLAT CORNICE WITH STANDARD NIGHT COVER	FACETED CORNICE WITH NIGHT COVER
		39 5/8" 	38 3/4" 	39 1/2" 	42 7/8" 	41 3/8" 	42 3/4" 
FRONT OPTIONS	FLAT FRONT 2	STANDARD FRONT  19 7/8" [50.5 cm]	2 1/2" EXTENDED FRONT *  22 3/8" [56.9 cm]	5" EXTENDED FRONT *  25" [63.5 cm]	7 1/2" EXTENDED FRONT *  27 3/8" [69.6 cm]		
	FLAT FRONT	STANDARD FRONT  18 3/4" [47.5 cm]	2 1/2" EXTENDED FRONT *  21 1/4" [53.9 cm]	5" EXTENDED FRONT *  23 3/4" [60.2 cm]	7 1/2" EXTENDED FRONT *  26 1/4" [66.6 cm]		
	CLASSIC 2 METAL	STANDARD FRONT  18 3/4" [47.5 cm]	2 1/2" EXTENDED FRONT *  21 1/4" [53.9 cm]	5" EXTENDED FRONT *  23 3/4" [60.2 cm]	7 1/2" EXTENDED FRONT *  26 1/4" [66.6 cm]		
	CLASSIC 2 POLYMER	STANDARD FRONT  18 3/4" [47.5 cm]	2 1/2" EXTENDED FRONT *  21 1/4" [53.9 cm]	5" EXTENDED FRONT *  23 3/4" [60.2 cm]	7 1/2" EXTENDED FRONT *  26 1/4" [66.6 cm]		
	ORIGIN 2	STANDARD FRONT  18 3/4" [47.5 cm]	2 1/2" EXTENDED FRONT *  21 1/4" [53.9 cm]	5" EXTENDED FRONT *  23 3/4" [60.2 cm]	7 1/2" EXTENDED FRONT *  26 1/4" [66.6 cm]		
	THERMOPANE	6" THERMOPANE FRONT  29 7/8" [75.8 cm]	4" THERMOPANE FRONT  27 7/8" [70.8 cm]	4" THERMOPANE FRONT *  27 7/8" [70.8 cm]	6" THERMOPANE FRONT  29 7/8" [75.8 cm]		

NOTES:

- * : W & W/O NOSE LIGHT.
- Tag molding materials are PVC, aluminum, or painted aluminum.
- See Ecoblade tech sheet for additional information.



O5DMH-NRG







ALL MEASUREMENTS ARE TAKEN PER ASHRAE-72 SPECIFICATIONS. HILLPHOENIX REFRIGERATED DISPLAY CASES FOR SALE IN THE UNITED STATES MEET OR EXCEED DEPARTMENT OF ENERGY 2017 REQUIREMENTS.

Rev. Date	Rev. #	Rev. Title
12-09-21	9	OPTION PAGE UPDATE
07-15-21	8	ENDVIEW UPDATE

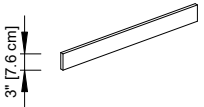
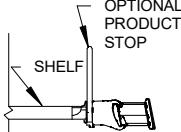

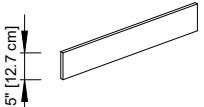
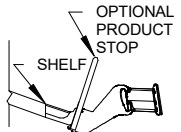
O5DMH-NRG

4', 6', 8' & 12' High Multi-Deck Merchandiser with Synerg-E™
Beverage / Bakery / Dairy / Cut Produce / Deli

SHELF TAG MOLDING OPTIONS	PRODUCT STOP OPTIONS (ONLY APPLICABLE ON SLOTTED TM)	SHELF EDGE ENERGY SAVINGS
<p><u>1.25" STD</u></p> 	<p><u>3" PLEXI PRODUCT STOPS</u></p> 	<p><u>ECO BLADE FLAT SHELF</u></p> 
<p><u>SLOTTED</u></p> 	<p><u>5" PLEXI PRODUCT STOPS</u></p> 	<p><u>ECO BLADE ANGLED SHELF</u></p> 
<p><u>ANGLED</u></p> 	<p><u>WIRE FENCE PRODUCT STOPS</u></p> 	
<p><u>ANGLED SLOTTED</u></p> 		

NOTES:

* : W & W/O NOSE LIGHT.

- Tag molding materials are PVC, aluminum, or painted aluminum.
- See Ecoblade tech sheet for additional information.



O5DMH-NRG

ALL MEASUREMENTS ARE TAKEN PER ASHRAE-72 SPECIFICATIONS. HILLPHOENIX REFRIGERATED DISPLAY CASES FOR SALE IN THE UNITED STATES MEET OR EXCEED DEPARTMENT OF ENERGY 2017 REQUIREMENTS.

Rev. Date	Rev. #	Rev. Title
12-09-21	9	OPTION PAGE UPDATE
07-15-21	8	ENDVIEW UPDATE



O5DMH-NRG

4', 6', 8' & 12' High Multi-Deck Merchandiser with Synerg-E™
Beverage / Bakery / Dairy / Cut Produce / Deli

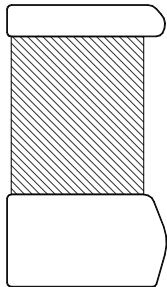
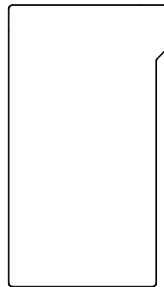
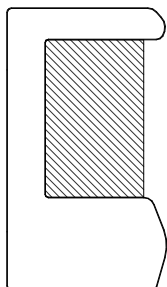
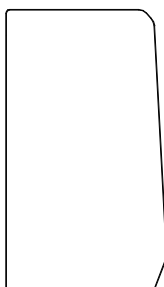
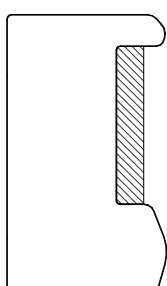
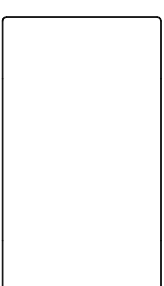
END STYLE OFFERINGS	
<p><u>SUPER VIEW</u></p> 	<p><u>SOLID (EXTENDED CANOPY)</u></p> 
<p><u>FULL VIEW</u></p> 	<p><u>SOLID (STANDARD CANOPY)</u></p> 
<p><u>REDUCED VIEW</u></p> 	<p><u>SQUARE</u></p> 

NOTES:

- Ends shown are for general use only. Shape, size, and appearance are subject to change based on engineering configuration.
- Hatched regions represent glass inserts.
- Ends are approximately 1 1/2" thick.
- Ends add approximately 1" to case height, 1/2" to the back & 1" to the front.
- Ends are available with either polymer end trim or metal end trim.



O5DMH-NRG

ALL MEASUREMENTS ARE TAKEN PER ASHRAE-72 SPECIFICATIONS. HILLPHOENIX REFRIGERATED DISPLAY CASES FOR SALE IN THE UNITED STATES MEET OR EXCEED DEPARTMENT OF ENERGY 2017 REQUIREMENTS.

Rev. Date	Rev. #	Rev. Title
12-09-21	9	OPTION PAGE UPDATE
07-15-21	8	ENDVIEW UPDATE



O5DMH-NRG

4', 6', 8' & 12' High Multi-Deck Merchandiser with Synerg-E™
Beverage / Bakery / Dairy / Cut Produce / Deli

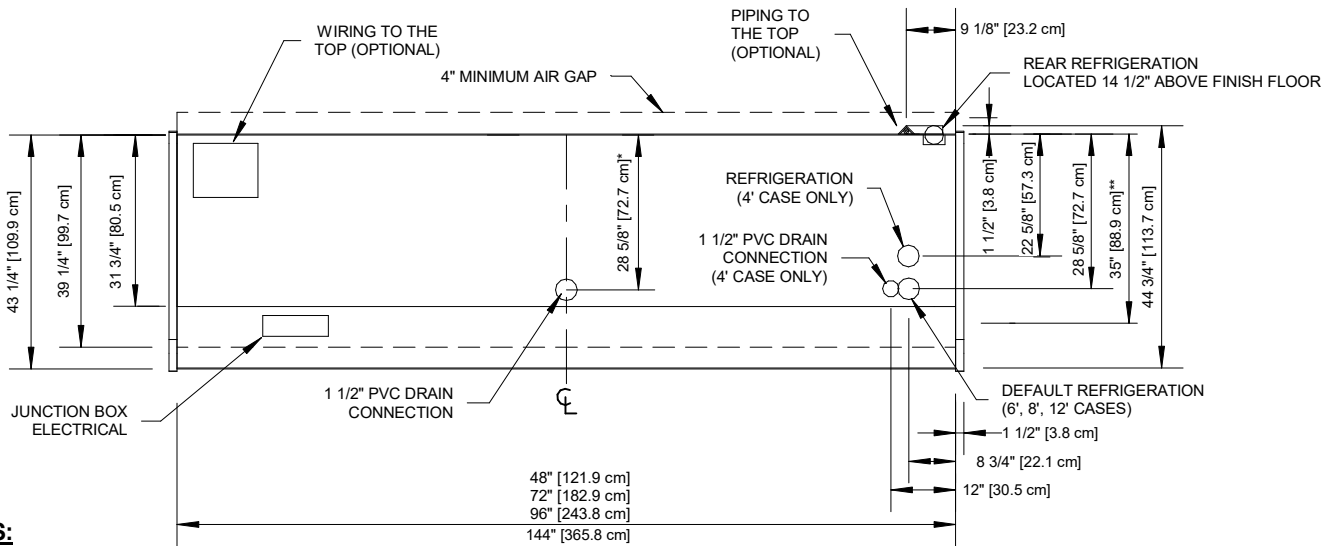
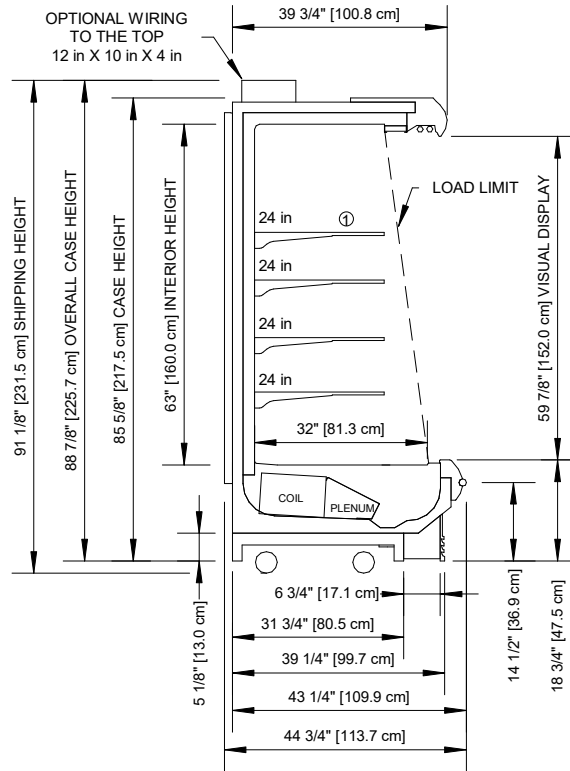

NOTES:

- * :STUB-UP AREA
- ** :RECOMMENDED STUB-UP CENTERLINE FOR ELECTRICAL AND DRAINS
- ① :AVAILABLE SHELF SIZES: 10", 12", 14", 16", 18", 20", 22" & 24"

- Ends add approximately 1" to case height, 1/2" to the back & 1" to the front
- Back panels add approximately 1" to the rear of the case.



O5DMH-NRG

ALL MEASUREMENTS ARE TAKEN PER ASHRAE-72 SPECIFICATIONS. HILLPHOENIX REFRIGERATED DISPLAY CASES FOR SALE IN THE UNITED STATES MEET OR EXCEED DEPARTMENT OF ENERGY 2017 REQUIREMENTS.

Rev. Date	Rev. #	Rev. Title
12-09-21	9	OPTION PAGE UPDATE
07-15-21	8	ENDVIEW UPDATE

