

# O5DMHQA-NRG

4', 6', 8' & 12' High Multi-Deck Merchandiser with Synerg-E™  
Beverage / Dairy / Deli / Produce

**SOLOCHILL**  
MICRO-DISTRIBUTED

**GENERAL NOTES:**

- "---" indicates that the feature is not an option on this case model and/or the data is not available at this time.
- LED lights only.
- Maximum of 5 rows of Standard Output LED lighted shelves.

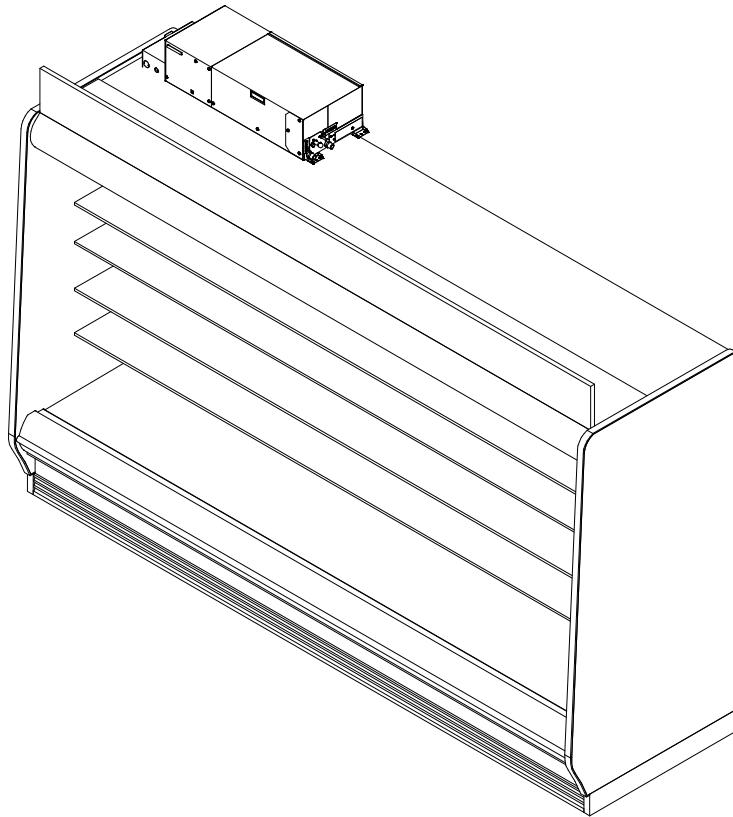

SHIPPING WEIGHT	
Case	Weight
O5DMHQA-NRG	---



ALL MEASUREMENTS ARE TAKEN PER ASHRAE-72-2005 SPECIFICATIONS. HILLPHOENIX REFRIGERATED DISPLAY CASES FOR SALE IN THE UNITED STATES MEET OR EXCEED DEPARTMENT OF ENERGY 2017 REQUIREMENTS.

**O5DMHQA-NRG**

Rev. Date	Rev. #	Rev. Title
9-28-20	4	SOLOCHILL V5
2-10-20	3	FASCIA UPDATE

**Hillphoenix**  
A DOVER COMPANY

# O5DMHQA-NRG

4', 6', 8' & 12' High Multi-Deck Merchandiser with Synerg-E™  
Beverage / Dairy / Deli / Produce



ELECTRICAL DATA			
Case Length	Fans Per Case	High Efficiency Fans	
		120 Volt	
		Amps	Watts
4'	1	0.23	18.0
6'	2	0.47	35.0
8'	2	0.47	35.0
12'	3	0.70	53.0

LIGHTING DATA					
Case Length	Lights per row	Clearvoyant v4 LED Lighting (Per Light Row)			
		Standard Power (Cornice or Shelf)		High Power (Cornice Only)	
		120 Volts		120 Volts	
		Amps	Watts	Amps	Watts
4'	1	0.05	5.9	0.12	14.9
6'	2	0.08	9.4	0.20	23.8
8'	2	0.10	11.8	0.25	29.9
12'	3	0.15	17.6	0.37	44.8

DEFROST CONTROLS		
Defrosts Per Day	Fail-Safe (Min)	Termination Temp (°F)
6	40	47

**NOTES:**

- "---" indicates that the feature is not an option on this case model and/or the data is not available at this time.
- Listed discharge air velocity represents the average velocity immediately after defrost.
- Temperature and defrost settings listed above are recommended start-up settings. Final operational settings may need to be adjusted for the store conditions in which the case operates



ALL MEASUREMENTS ARE TAKEN PER ASHRAE-72-2005 SPECIFICATIONS. HILLPHOENIX REFRIGERATED DISPLAY CASES FOR SALE IN THE UNITED STATES MEET OR EXCEED DEPARTMENT OF ENERGY 2017 REQUIREMENTS.

**O5DMHQA-NRG**

Rev. Date	Rev. #	Rev. Title
9-28-20	4	SOLOCHILL V5
2-10-20	3	FASCIA UPDATE



A DOVER COMPANY

# O5DMHQA-NRG

4', 6', 8' & 12' High Multi-Deck Merchandiser with Synerg-E™  
Beverage / Dairy / Deli / Produce



SOLOCHILL DATA			@95° Condensing Temperature			
Volts	Phase	Frequency	Wire			
208	1	60	3 Wire + Ground			
Application			Case Length	Evaporator Temp (°F)	Discharge Air (°F)	Discharge Air Velocity (FPM)
BEVERAGE/BULK PRODUCE			4'	32	37	150
BEVERAGE/BULK PRODUCE			6'	32	37	150
BEVERAGE/BULK PRODUCE			8'	32	37	150
BEVERAGE/BULK PRODUCE			12'	32	37	150
DAIRY/DELI/CUT PRODUCE			4'	26	31	150
DAIRY/DELI/CUT PRODUCE			6'	26	31	150
DAIRY/DELI/CUT PRODUCE			8'	26	31	150
DAIRY/DELI/CUT PRODUCE			12'	26	31	150

Application	Case Length	R448A					
		Condensing Unit Model	MCA	MOP	Required Capacity	THR (BTUH)	Flow Rate
BEVERAGE/BULK PRODUCE	4'	DA130	11.0	15	5504	6732	1.9
BEVERAGE/BULK PRODUCE	6'	DA220	17.8	20	8256	9920	2.8
BEVERAGE/BULK PRODUCE	8'	DA220	18.1	20	11008	13175	3.8
BEVERAGE/BULK PRODUCE	12'	DA420	36.5	40	16512	20046	5.7
DAIRY/DELI/CUT PRODUCE	4'	DA130	11.0	15	6464	8073	2.3
DAIRY/DELI/CUT PRODUCE	6'	DA220	17.8	20	9696	11859	3.4
DAIRY/DELI/CUT PRODUCE	8'	DA220	18.1	20	12928	15772	4.5
DAIRY/DELI/CUT PRODUCE	12'	DA420	36.5	40	19392	23971	6.9



ALL MEASUREMENTS ARE TAKEN PER ASHRAE-72-2005 SPECIFICATIONS. HILLPHOENIX REFRIGERATED DISPLAY CASES FOR SALE IN THE UNITED STATES MEET OR EXCEED DEPARTMENT OF ENERGY 2017 REQUIREMENTS.

## O5DMHQA-NRG

Rev. Date	Rev. #	Rev. Title
9-28-20	4	SOLOCHILL V5
2-10-20	3	FASCIA UPDATE



A DOVER COMPANY

# O5DMHQA-NRG

4', 6', 8' & 12' High Multi-Deck Merchandiser with Synerg-E™  
Beverage / Dairy / Deli / Produce



FRONT OPTIONS	CORNICE OPTIONS					
	CURVED CORNICE 39 5/8"	CURVED CORNICE WITH NIGHT COVER 42 7/8"	FACETED CORNICE 39 1/2"	FACETED CORNICE WITH NIGHT COVER 42 3/4"	FLAT CORNICE 38 3/4"	FLAT CORNICE WITH STANDARD NIGHT COVER 41 3/8"
FLAT FRONT 2	STANDARD FRONT 19 7/8" [50.5 cm]	2 1/2" EXTENDED FRONT W/ & W/O NOSE LIGHT 22 3/8" [56.9 cm]	5" EXTENDED FRONT W/ & W/O NOSE LIGHT 25" [63.5 cm]	7 1/2" EXTENDED FRONT 27 3/8" [69.6 cm]		
FLAT FRONT	STANDARD FRONT 18 11/16" [47.5 cm]	2 1/2" EXTENDED FRONT W/ & W/O NOSE LIGHT 21 3/16" [53.9 cm]	5" EXTENDED FRONT W/ & W/O NOSE LIGHT 23 11/16" [60.2 cm]	7 1/2" EXTENDED FRONT 26 3/16" [66.6 cm]		
CLASSIC 2 METAL	STANDARD FRONT 18 11/16" [47.5 cm]	2 1/2" EXTENDED FRONT W/ & W/O NOSE LIGHT 21 3/16" [53.9 cm]	5" EXTENDED FRONT W/ & W/O NOSE LIGHT 23 11/16" [60.2 cm]	7 1/2" EXTENDED FRONT 26 3/16" [66.6 cm]		
CLASSIC 2 POLYMER	STANDARD FRONT 18 11/16" [47.5 cm]	2 1/2" EXTENDED FRONT W/ & W/O NOSE LIGHT 21 3/16" [53.9 cm]	5" EXTENDED FRONT W/ & W/O NOSE LIGHT 23 11/16" [60.2 cm]	7 1/2" EXTENDED FRONT 26 3/16" [66.6 cm]		
ORIGIN 2	STANDARD FRONT 18 11/16" [47.5 cm]	2 1/2" EXTENDED FRONT W/ & W/O NOSE LIGHT 21 3/16" [53.9 cm]	5" EXTENDED FRONT W/ & W/O NOSE LIGHT 23 11/16" [60.2 cm]	7 1/2" EXTENDED FRONT 26 3/16" [66.6 cm]		
THERMOPANE	6" THERMOPANE FRONT 29 7/8" [75.8 cm]	4" THERMOPANE FRONT 27 7/8" [70.8 cm]	4" THERMOPANE FRONT W/T NOSE LIGHT 27 7/8" [70.8 cm]	6" THERMOPANE FRONT 29 7/8" [75.9 cm]		

**NOTES:**



ALL MEASUREMENTS ARE TAKEN PER ASHRAE-72-2005 SPECIFICATIONS. HILLPHOENIX REFRIGERATED DISPLAY CASES FOR SALE IN THE UNITED STATES MEET OR EXCEED DEPARTMENT OF ENERGY 2017 REQUIREMENTS.

**O5DMHQA-NRG**

Rev. Date	Rev. #	Rev. Title
9-28-20	4	SOLOCHILL V5
2-10-20	3	FASCIA UPDATE



A DOVER COMPANY

# O5DMHQA-NRG

4', 6', 8' & 12' High Multi-Deck Merchandiser with Synerg-E™  
Beverage / Dairy / Deli / Produce



## SOLOCHILL UNIT OPTIONS

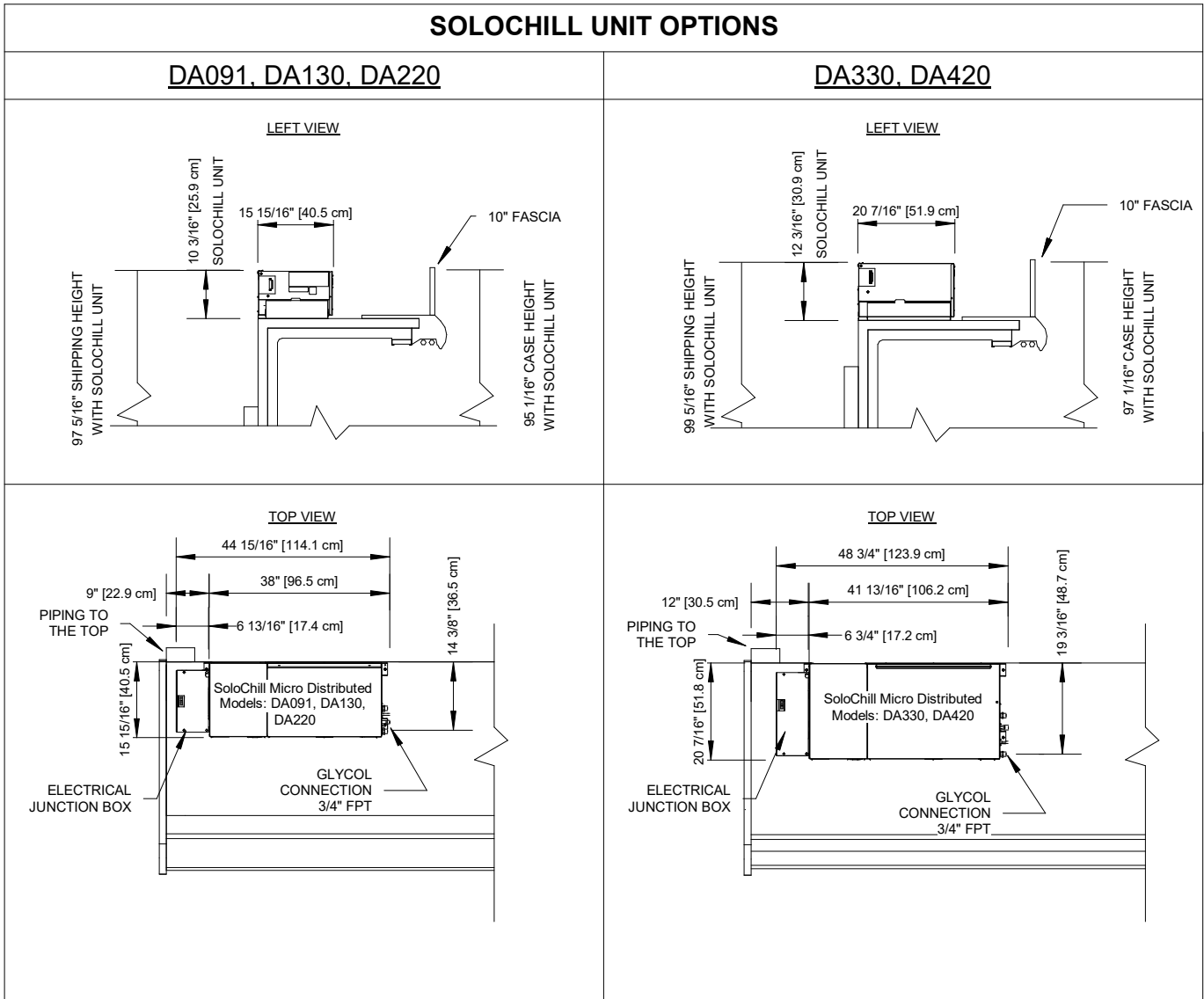

ALL MEASUREMENTS ARE TAKEN PER ASHRAE-72-2005 SPECIFICATIONS. HILLPHOENIX REFRIGERATED DISPLAY CASES FOR SALE IN THE UNITED STATES MEET OR EXCEED DEPARTMENT OF ENERGY 2017 REQUIREMENTS.

### O5DMHQA-NRG

Rev. Date	Rev. #	Rev. Title
9-28-20	4	SOLOCHILL V5
2-10-20	3	FASCIA UPDATE



A DOVER COMPANY

# O5DMHQA-NRG

4', 6', 8' & 12' High Multi-Deck Merchandiser with Synerg-E™  
Beverage / Dairy / Deli / Produce

**SOLOCHILL**  
MICRO-DISTRIBUTED

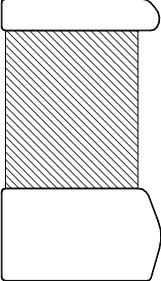
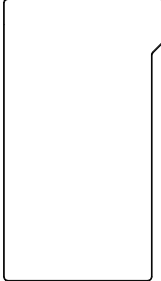
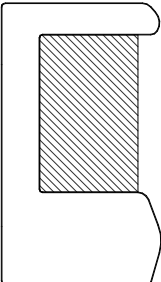
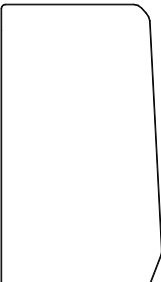
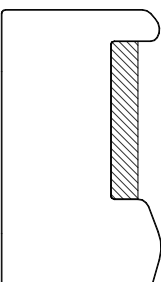
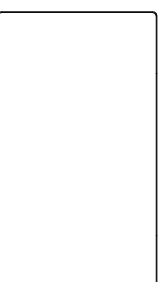
END STYLE OFFERINGS	
<p><u>SUPER VIEW</u></p> 	<p><u>SOLID (EXTENDED CANOPY)</u></p> 
<p><u>FULL VIEW</u></p> 	<p><u>SOLID (STANDARD CANOPY)</u></p> 
<p><u>REDUCED VIEW</u></p> 	<p><u>SQUARE</u></p> 

**NOTES:**

- Ends shown are for general use only. Shape, size, and appearance are subject to change based on engineering configuration.
- Hatched regions represent glass inserts.
- Ends are approximately 1 1/2" thick.
- Ends add approximately 1" to case height, 1/2" to the back & 1" to the front.
- Ends are available with either polymer end trim or metal end trim.



ALL MEASUREMENTS ARE TAKEN PER ASHRAE-72-2005 SPECIFICATIONS. HILLPHOENIX REFRIGERATED DISPLAY CASES FOR SALE IN THE UNITED STATES MEET OR EXCEED DEPARTMENT OF ENERGY 2017 REQUIREMENTS.

**O5DMHQA-NRG**

Rev. Date	Rev. #	Rev. Title
9-28-20	4	SOLOCHILL V5
2-10-20	3	FASCIA UPDATE

**Hillphoenix**  
A DOVER COMPANY

# O5DMHQA-NRG

4', 6', 8' & 12' High Multi-Deck Merchandiser with Synerg-E™  
Beverage / Dairy / Deli / Produce

**SOLOCHILL**  
MICRO-DISTRIBUTED

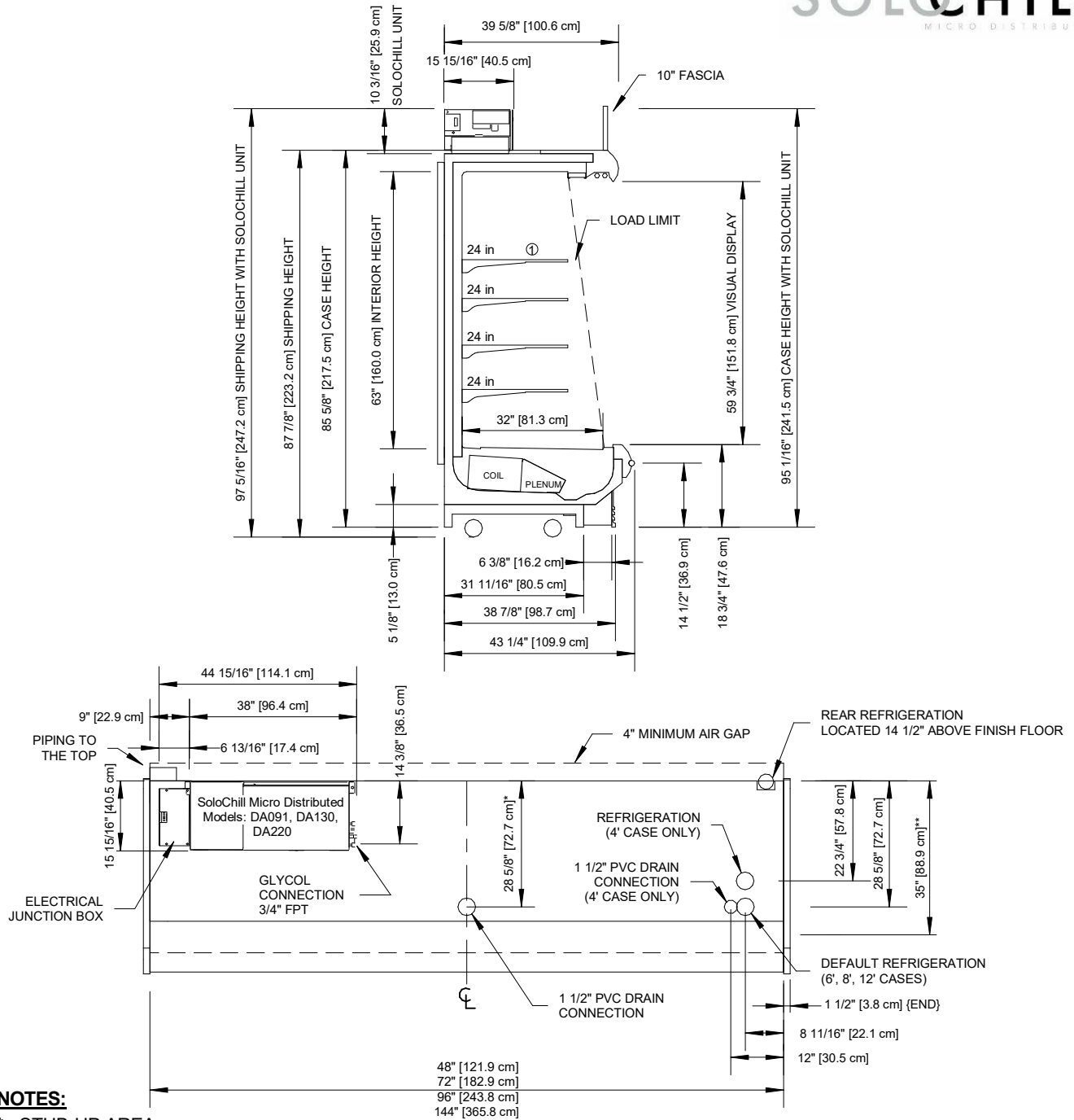

**NOTES:**

- \* :STUB-UP AREA
- \*\* :RECOMMENDED STUB-UP CENTERLINE FOR ELECTRICAL AND DRAINS
- ① :AVAILABLE SHELF SIZES: 10", 12", 14", 16", 18", 20", 22" & 24"

- Ends add approximately 1" to case height, 1/2" to the back & 1" to the front
- Back panels add approximately 1" to the rear of the case.



**O5DMHQA-NRG**

ALL MEASUREMENTS ARE TAKEN PER ASHRAE-72-2005 SPECIFICATIONS. HILLPHOENIX REFRIGERATED DISPLAY CASES FOR SALE IN THE UNITED STATES MEET OR EXCEED DEPARTMENT OF ENERGY 2017 REQUIREMENTS.

Rev. Date	Rev. #	Rev. Title
9-28-20	4	SOLOCHILL V5
2-10-20	3	FASCIA UPDATE

**Hillphoenix**  
A DOVER COMPANY