

OHMQA-NRG

4', 6', 8' & 12' Multi-Deck Merchandiser
Deli / Meat / Seafood

SOLOCHILL
MICRO-DISTRIBUTED

GENERAL NOTES:

- "---" indicates that the feature is not an option on this case model and/or the data is not available at this time.
- LED lights only.

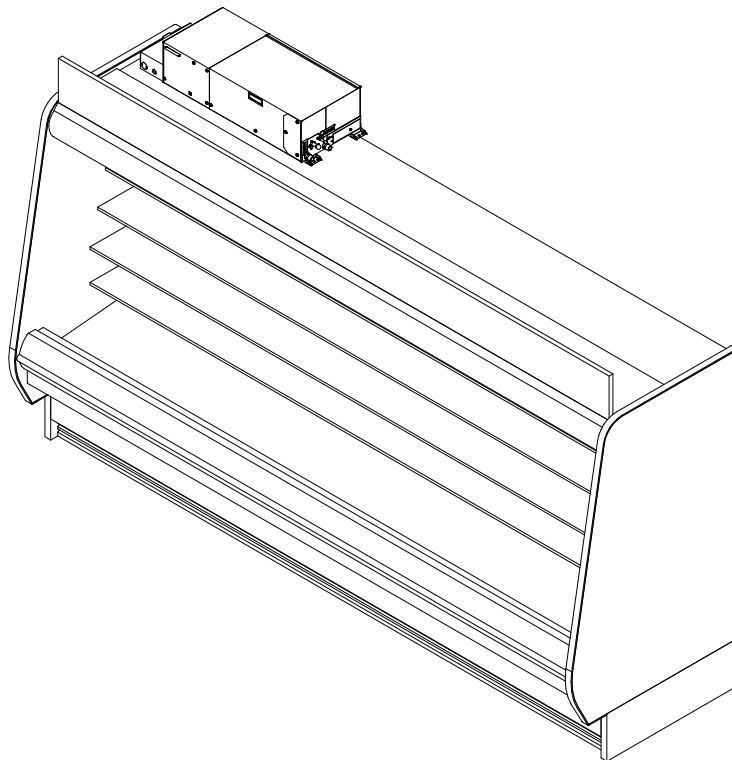

SHIPPING WEIGHT	
Case	Weight
OHMQA-NRG	---



ALL MEASUREMENTS ARE TAKEN PER ASHRAE-72 SPECIFICATIONS. HILLPHOENIX REFRIGERATED DISPLAY CASES FOR SALE IN THE UNITED STATES MEET OR EXCEED DEPARTMENT OF ENERGY 2017 REQUIREMENTS.

OHMQA-NRG

Rev. Date	Rev. #	Rev. Title
10-20-20	4	SOLOCHILL V5
2-11-20	3	FASCIA UPDATE

Hillphoenix
A DOVER COMPANY

OHMQA-NRG

4', 6', 8' & 12' Multi-Deck Merchandiser
Deli / Meat / Seafood



ELECTRICAL DATA			
Case Length	Fans Per Case	High Efficiency Fans	
		120 Volt	
		Amps	Watts
4'	2	0.50	36.0
6'	3	0.75	54.0
8'	3	0.75	54.0
12'	4	1.00	72.0

LIGHTING DATA					
Case Length	Lights per row	Clearvoyant v4 LED Lighting (Per Light Row)			
		Standard Power (Cornice or Shelf)		High Power (Cornice Only)	
		120 Volts		120 Volts	
		Amps	Watts	Amps	Watts
4'	1	0.05	5.9	0.12	14.9
6'	2	0.08	9.4	0.20	23.8
8'	2	0.10	11.8	0.25	29.9
12'	3	0.15	17.6	0.37	44.8

DEFROST CONTROLS		
Defrosts Per Day	Timed-Off Defrost	
	Fail-Safe (Min)	Termination Temp (F)
6	40	47

NOTES:

- "---" indicates that the feature is not an option on this case model and/or the data is not available at this time.
- Listed discharge air velocity represents the average velocity immediately after defrost.
- Temperature and defrost settings listed above are recommended start-up settings. Final operational settings may need to be adjusted for the store conditions in which the case operates.



ALL MEASUREMENTS ARE TAKEN PER ASHRAE-72 SPECIFICATIONS. HILLPHOENIX REFRIGERATED DISPLAY CASES FOR SALE IN THE UNITED STATES MEET OR EXCEED DEPARTMENT OF ENERGY 2017 REQUIREMENTS.

OHMQA-NRG

Rev. Date	Rev. #	Rev. Title
10-20-20	4	SOLOCHILL V5
2-11-20	3	FASCIA UPDATE



A DOVER COMPANY

OHMQA-NRG

4', 6', 8' & 12' Multi-Deck Merchandiser
Deli / Meat / Seafood



SOLOCHILL DATA			@95° Condensing Temperature		
Volts	Phase	Frequency	Wire		
208	1	60	3 Wire + Ground		
Application		Case Length	Evaporator Temp (°F)	Discharge Air (°F)	Discharge Air Velocity (FPM)
DAIRY/DELI/CUT PRODUCE		4'	25	30	200
DAIRY/DELI/CUT PRODUCE		6'	25	30	200
DAIRY/DELI/CUT PRODUCE		8'	25	30	200
DAIRY/DELI/CUT PRODUCE		12'	25	30	200
MEAT		4'	25	30	200
MEAT		6'	25	30	200
MEAT		8'	25	30	200
MEAT		12'	25	30	200

Application	Case Length	R448A					
		Condensing Unit Model	MCA	MOP	Required Capacity	THR (BTUH)	Flow Rate
DAIRY/DELI/CUT PRODUCE	4'	DA130	11.5	15	5628	7065	2.0
DAIRY/DELI/CUT PRODUCE	6'	DA130	12.2	15	8442	10579	3.0
DAIRY/DELI/CUT PRODUCE	8'	DA220	18.6	20	11256	13796	4.0
DAIRY/DELI/CUT PRODUCE	12'	DA330	27.1	30	16884	21062	6.0
MEAT	4'	DA130	11.5	15	5144	7065	2.0
MEAT	6'	DA130	12.2	15	7716	10579	3.0
MEAT	8'	DA220	18.6	20	10288	13796	4.0
MEAT	12'	DA330	27.1	30	15432	21062	6.0









ALL MEASUREMENTS ARE TAKEN PER ASHRAE-72 SPECIFICATIONS. HILLPHOENIX REFRIGERATED DISPLAY CASES FOR SALE IN THE UNITED STATES MEET OR EXCEED DEPARTMENT OF ENERGY 2017 REQUIREMENTS.

OHMQA-NRG

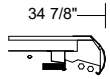
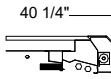
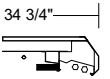
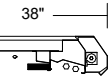
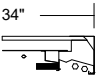
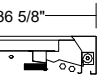
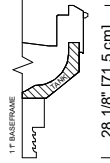
Rev. Date	Rev. #	Rev. Title
10-20-20	4	SOLOCHILL V5
2-11-20	3	FASCIA UPDATE

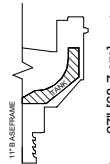
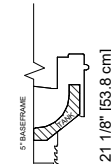
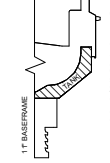
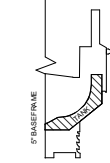
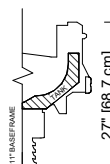
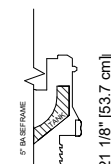
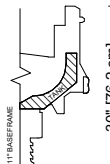
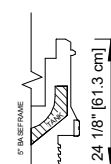
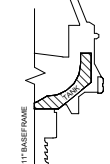
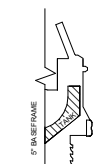
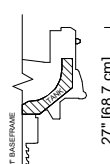
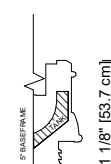
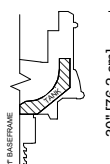
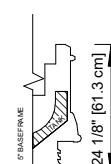
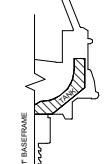
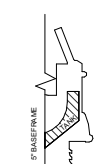

A DOVER COMPANY

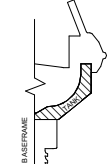
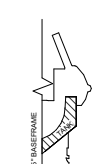
FRONT OPTIONS	CORNICHE OPTIONS						
	CURVED CORNICHE	CURVED CORNICHE WITH NIGHT COVER	FACETED CORNICHE	FACETED CORNICHE WITH NIGHT COVER	FLAT CORNICHE	FLAT CORNICHE WITH STANDARD NIGHT COVER	
FRONT OPTIONS	FLAT FRONT 2						
	FLAT FRONT						
	CLASSIC 2 METAL						
	CLASSIC 2 POLYMER						
	ORIGIN 2						

NOTES:

- Front sill height and overall case height varies with base frame height.
- Extended front sills are required on meat applications to maintain proper temperature. An extended front has a minimum height of 24" on a 5" baseframe or 30" on an 11" baseframe.



COMPONENT

ALL MEASUREMENTS ARE TAKEN PER ASHRAE-72 SPECIFICATIONS. HILLPHOENIX REFRIGERATED DISPLAY CASES FOR SALE IN THE UNITED STATES MEET OR EXCEED DEPARTMENT OF ENERGY 2017 REQUIREMENTS.

OHMQA-NRG

Rev. Date	Rev. #	Rev. Title
10-20-20	4	SOLOCHILL V5
2-11-20	3	FASCIA UPDATE



A DOVER COMPANY

SOLOCHILL UNIT OPTIONS

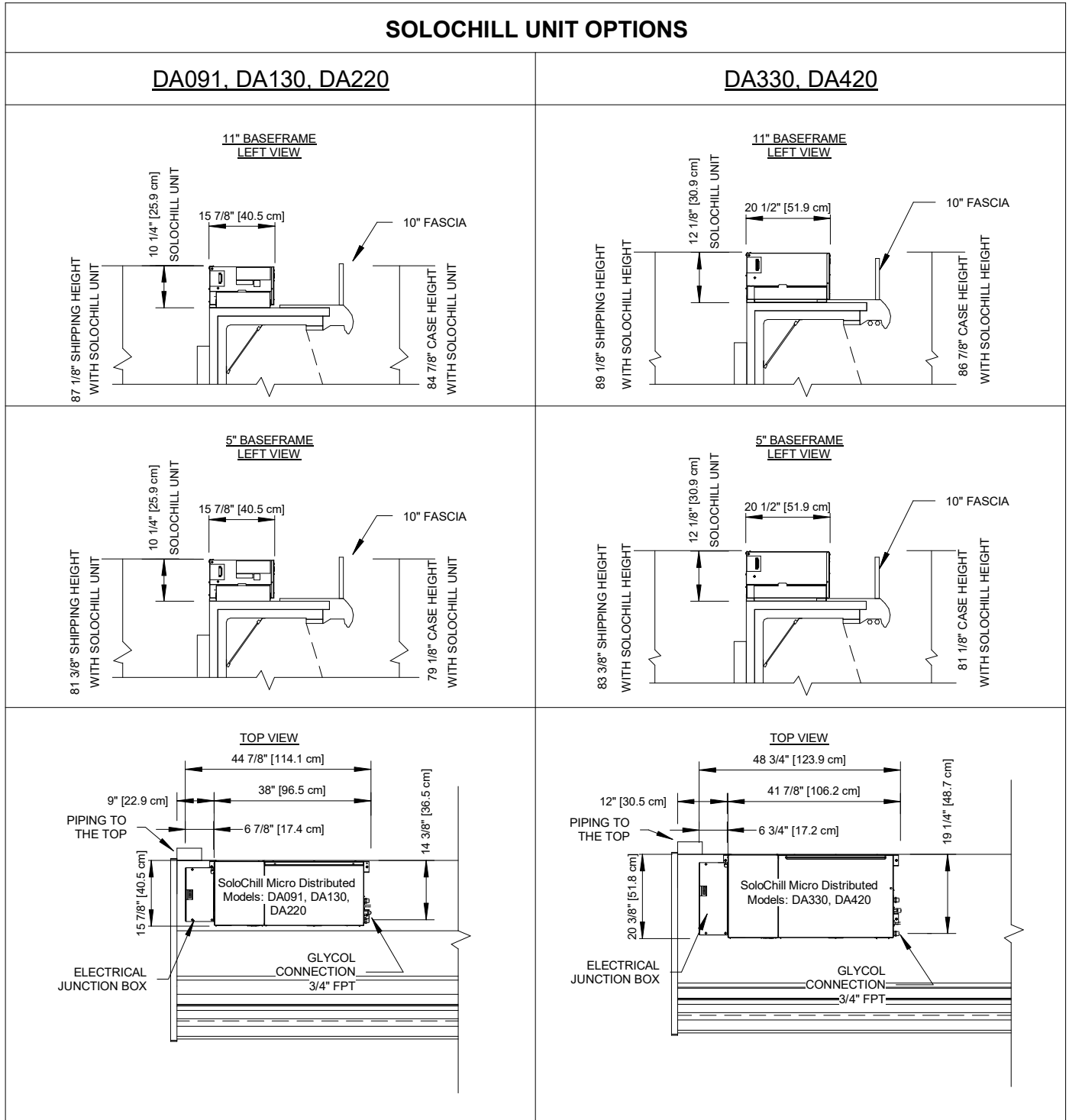

ALL MEASUREMENTS ARE TAKEN PER ASHRAE-72 SPECIFICATIONS. HILLPHOENIX REFRIGERATED DISPLAY CASES FOR SALE IN THE UNITED STATES MEET OR EXCEED DEPARTMENT OF ENERGY 2017 REQUIREMENTS.

OHMQA-NRG

Rev. Date	Rev. #	Rev. Title
10-20-20	4	SOLOCHILL V5
2-11-20	3	FASCIA UPDATE

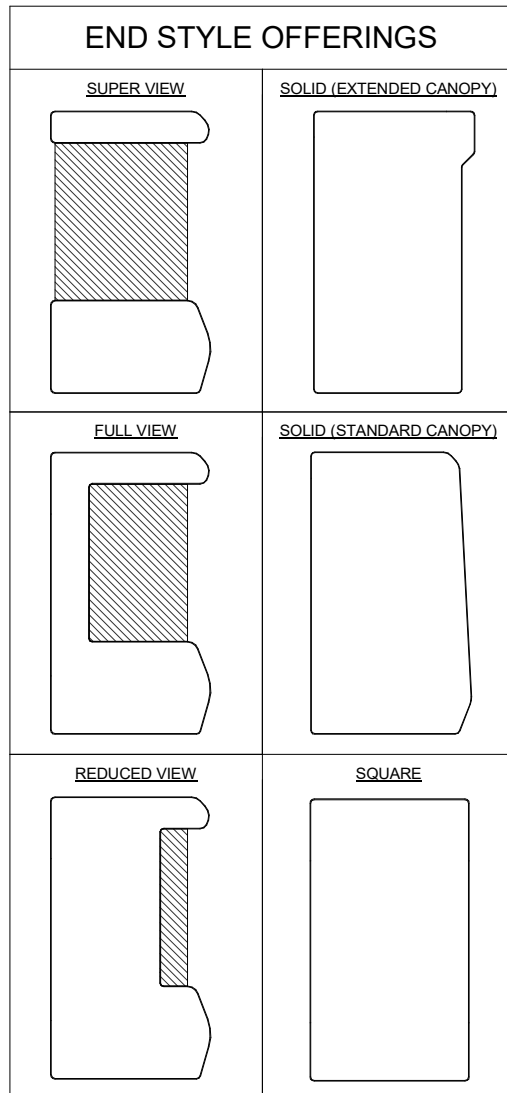

NOTES:

- Ends shown are for general use only. Shape, size, and appearance are subject to change based on engineering configuration.
- Hatched regions represent glass inserts.
- Ends add approximately 1" to case height, 1/2" to the back & 1" to the front.
- Ends are available with either polymer end trim or metal end trim.



ALL MEASUREMENTS ARE TAKEN PER ASHRAE-72 SPECIFICATIONS. HILLPHOENIX REFRIGERATED DISPLAY CASES FOR SALE IN THE UNITED STATES MEET OR EXCEED DEPARTMENT OF ENERGY 2017 REQUIREMENTS.

OHMQA-NRG

Rev. Date	Rev. #	Rev. Title
10-20-20	4	SOLOCHILL V5
2-11-20	3	FASCIA UPDATE



OHMQA-NRG

4', 6', 8' & 12' Multi-Deck Merchandiser
Deli / Meat / Seafood

SOLOCHILL
MICRO-DISTRIBUTED

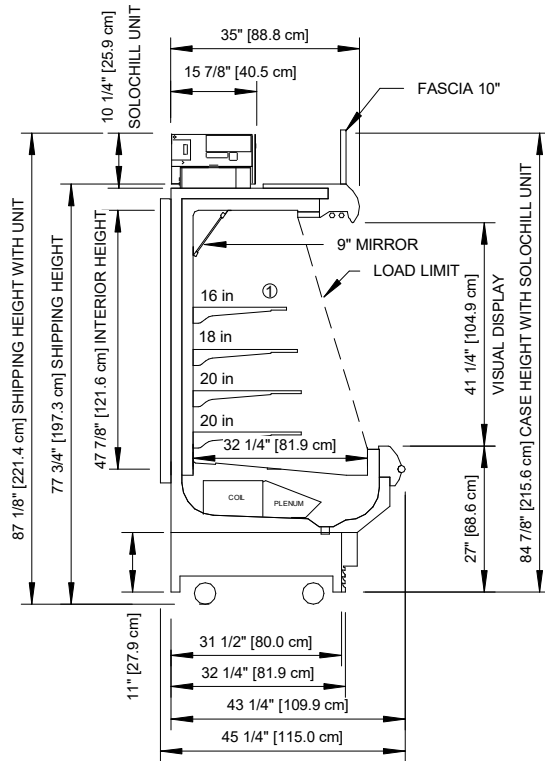

11" BASEFRAME

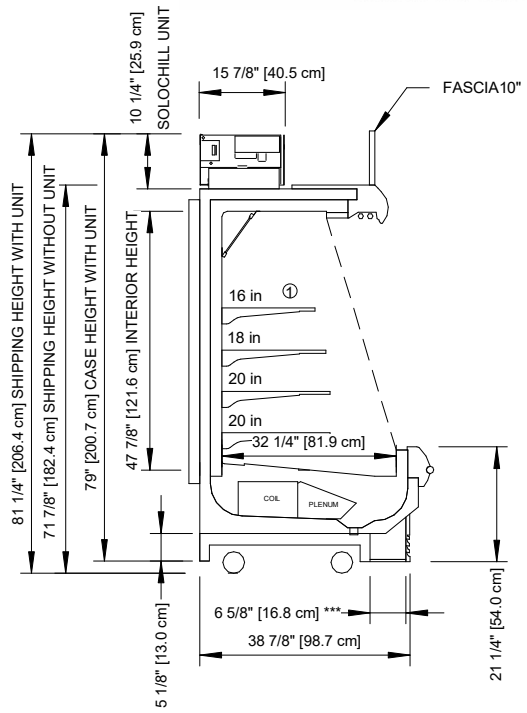

5" BASEFRAME

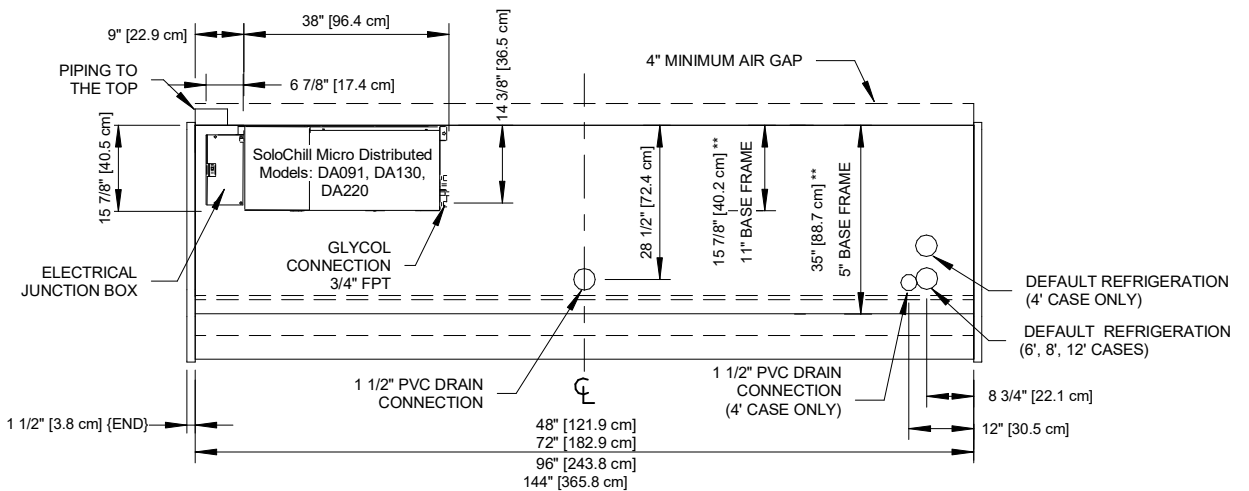

NOTES:

* :STUB-UP AREA

** :RECOMMENDED STUB-UP CENTERLINE FOR ELECTRICAL AND HUB DRAINS

① :AVAILABLE SHELF SIZES: 16", 18", & 20" Articulating or 14", 16", 18", 20", 22" & 24" Standard ; (5) ROWS OF SHELVES MAX

- Ends add approximately 1" to case height, 1/2" to the back & 1" to the front.
- Back panels add approximately 1" to the rear of the case.



ALL MEASUREMENTS ARE TAKEN PER ASHRAE-72 SPECIFICATIONS. HILLPHOENIX REFRIGERATED DISPLAY CASES FOR SALE IN THE UNITED STATES MEET OR EXCEED DEPARTMENT OF ENERGY 2017 REQUIREMENTS.

OHMQA-NRG

Rev. Date	Rev. #	Rev. Title
10-20-20	4	SOLOCHILL V5
2-11-20	3	FASCIA UPDATE

