

OMMQA

4', 6', 8' & 12' Single-Deck Merchandiser
Deli / Meat / Seafood

SOLOCHILL
MICRO-DISTRIBUTED

GENERAL NOTES:

- " --- " indicates that the feature is not an option with this case model and/or that the data is not available at this time.

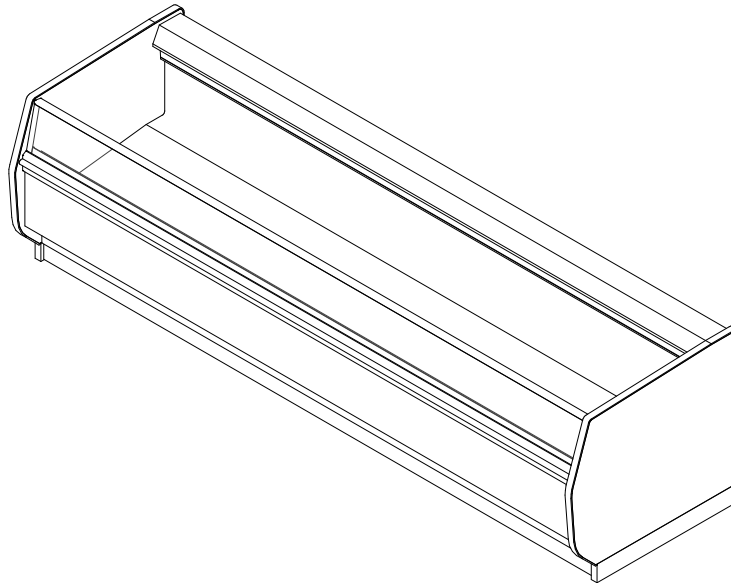

SHIPPING WEIGHT	
Case	Weight
OMMQA-NRG	---



ALL MEASUREMENTS ARE TAKEN PER ASHRAE-72-2005 SPECIFICATIONS. HILLPHOENIX REFRIGERATED DISPLAY CASES FOR SALE IN THE UNITED STATES MEET OR EXCEED DEPARTMENT OF ENERGY 2017 REQUIREMENTS.

OMMQA

Rev. Date	Rev. #	Rev. Title
9-30-20	1	SOLOCHILL V5
03-16-20	0	SOLOCHILL V4

Hillphoenix
A DOVER COMPANY

ELECTRICAL DATA									
Case Length	Fans Per Case	High Efficiency Fans		Anti Condensate Heaters		Defrost Heaters			
		Open Case		Open Case		208 Volts		240 Volts	
		120 Volt		120 Volts		Amps	Watts	Amps	Watts
		Amps	Watts	Amps	Watts				
4'	2	0.72	45.7	0.31	36.77	1.92	400	2.22	532
6'	3	1.07	68.5	0.46	54.57	2.88	600	3.33	798
8'	3	1.07	68.5	0.62	73.59	3.85	800	4.44	1065
12'	4	1.43	91.3	0.93	110.32	5.77	1200	6.67	1600

DEFROST CONTROLS					
Defrosts Per Day	Electric Defrost			Timed-Off Defrost	
	Fail-Safe (Min)	Termination Temp (°F)	Drip Time (Min)	Fail-Safe (Min)	Termination Temp (°F)
4	30	44	0	45	45

NOTES

- "---" indicates that the feature is not an option on this case model and/or the data is not yet available.
- Listed discharge air velocity represents the average velocity at the peak of defrost.
- Temperature and defrost settings listed above are recommended start-up settings. Final operational settings may need to be adjusted for the store conditions in which the case operates.



ALL MEASUREMENTS ARE TAKEN PER ASHRAE-72-2005 SPECIFICATIONS. HILLPHOENIX REFRIGERATED DISPLAY CASES FOR SALE IN THE UNITED STATES MEET OR EXCEED DEPARTMENT OF ENERGY 2017 REQUIREMENTS.

OMMQA

Rev. Date	Rev. #	Rev. Title
9-30-20	1	SOLOCHILL V5
03-16-20	0	SOLOCHILL V4

OMMQA

4', 6', 8' & 12' Single-Deck Merchandiser
Deli / Meat / Seafood



SOLOCHILL DATA			@95° Condensing Temperature		
Volts	Phase	Frequency	Wire		
208	1	60	3 Wire + Ground		
Application		Case Length	Evaporator Temp (°F)	Discharge Air (°F)	Discharge Air Velocity (FPM)
Standard		4'	17	25	300
Standard		6'	17	25	300
Standard		8'	17	25	300
Standard		12'	17	25	300

Application	Case Length	R448A					
		Condensing Unit Model	MCA	MOP	Required Capacity	THR (BTUH)	Flow Rate
Standard	4'	DA091	8.4	15	3360	4499	1.3
Standard	6'	DA130	11.5	15	5040	6549	1.9
Standard	8'	DA130	11.5	15	6720	8721	2.5
Standard	12'	DA220	18.1	20	10080	12747	3.7





ALL MEASUREMENTS ARE TAKEN PER ASHRAE-72-2005 SPECIFICATIONS. HILLPHOENIX REFRIGERATED DISPLAY CASES FOR SALE IN THE UNITED STATES MEET OR EXCEED DEPARTMENT OF ENERGY 2017 REQUIREMENTS.

OMMQA

Rev. Date	Rev. #	Rev. Title
9-30-20	1	SOLOCHILL V5
03-16-20	0	SOLOCHILL V4

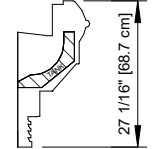
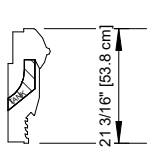
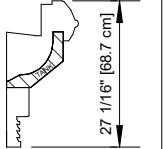
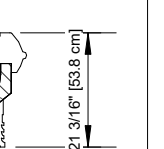
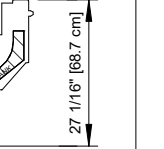
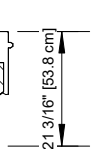
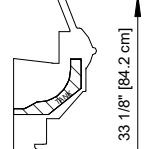
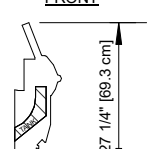
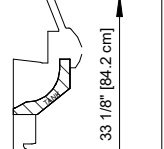
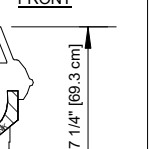
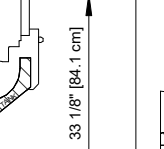
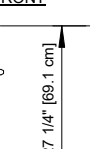
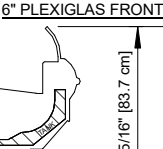
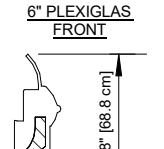
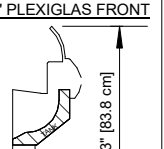
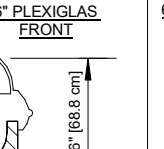
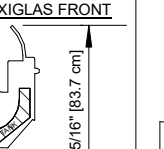
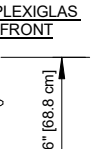
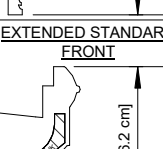
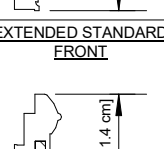
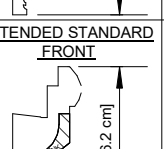
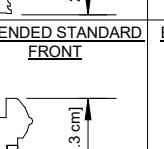
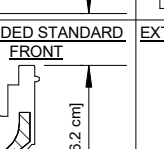
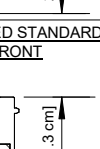
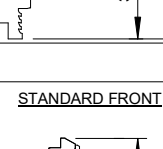

A DOVER COMPANY

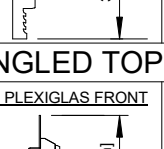
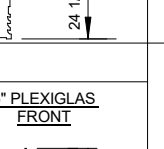
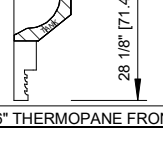
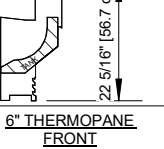
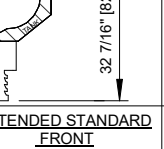
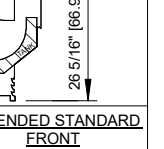
FRONT OPTIONS					
ORIGIN 2 FRONT				FLAT FRONT FLAT TOP	
<u>STANDARD FRONT</u>  27 1/16" [68.7 cm]	<u>STANDARD FRONT</u>  21 3/16" [53.8 cm]	<u>STANDARD FRONT</u>  27 1/16" [68.7 cm]	<u>STANDARD FRONT</u>  21 3/16" [53.8 cm]	<u>STANDARD FRONT</u>  27 1/16" [68.7 cm]	<u>STANDARD FRONT</u>  21 3/16" [53.8 cm]
<u>6" THERMOPANE FRONT</u>  33 1/8" [84.2 cm]	<u>6" THERMOPANE FRONT</u>  27 1/4" [69.3 cm]	<u>6" THERMOPANE FRONT</u>  33 1/8" [84.2 cm]	<u>6" THERMOPANE FRONT</u>  27 1/4" [69.3 cm]	<u>6" THERMOPANE FRONT</u>  33 1/8" [84.1 cm]	<u>6" THERMOPANE FRONT</u>  27 1/4" [69.1 cm]
<u>6" PLEXIGLAS FRONT</u>  32 15/16" [83.7 cm]	<u>6" PLEXIGLAS FRONT</u>  27 1/8" [68.8 cm]	<u>6" PLEXIGLAS FRONT</u>  33" [83.8 cm]	<u>6" PLEXIGLAS FRONT</u>  27 1/16" [68.8 cm]	<u>6" PLEXIGLAS FRONT</u>  32 15/16" [83.7 cm]	<u>6" PLEXIGLAS FRONT</u>  27 1/16" [68.8 cm]
<u>EXTENDED STANDARD FRONT</u>  30" [76.2 cm]	<u>EXTENDED STANDARD FRONT</u>  24 3/16" [61.4 cm]	<u>EXTENDED STANDARD FRONT</u>  30" [76.2 cm]	<u>EXTENDED STANDARD FRONT</u>  24 1/8" [61.3 cm]	<u>EXTENDED STANDARD FRONT</u>  30" [76.2 cm]	<u>EXTENDED STANDARD FRONT</u>  24 1/8" [61.3 cm]
FLAT FRONT ANGLED TOP					
<u>STANDARD FRONT</u>  28 1/8" [71.4 cm]	<u>STANDARD FRONT</u>  22 5/16" [56.7 cm]	<u>6" PLEXIGLAS FRONT</u>  32 7/16" [82.3 cm]	<u>6" PLEXIGLAS FRONT</u>  26 5/16" [66.9 cm]		
<u>6" THERMOPANE FRONT</u>  33 7/16" [84.9 cm]	<u>6" THERMOPANE FRONT</u>  27 3/8" [69.5 cm]	<u>EXTENDED STANDARD FRONT</u>  33" [83.8 cm]	<u>EXTENDED STANDARD FRONT</u>  27" [68.6 cm]		



COMPONENT

ALL MEASUREMENTS ARE TAKEN PER ASHRAE-72-2005 SPECIFICATIONS. HILLPHOENIX REFRIGERATED DISPLAY CASES FOR SALE IN THE UNITED STATES MEET OR EXCEED DEPARTMENT OF ENERGY 2017 REQUIREMENTS.

OMMQA

Rev. Date	Rev. #	Rev. Title
9-30-20	1	SOLOCHILL V5
03-16-20	0	SOLOCHILL V4

Hillphoenix

A DOVER COMPANY

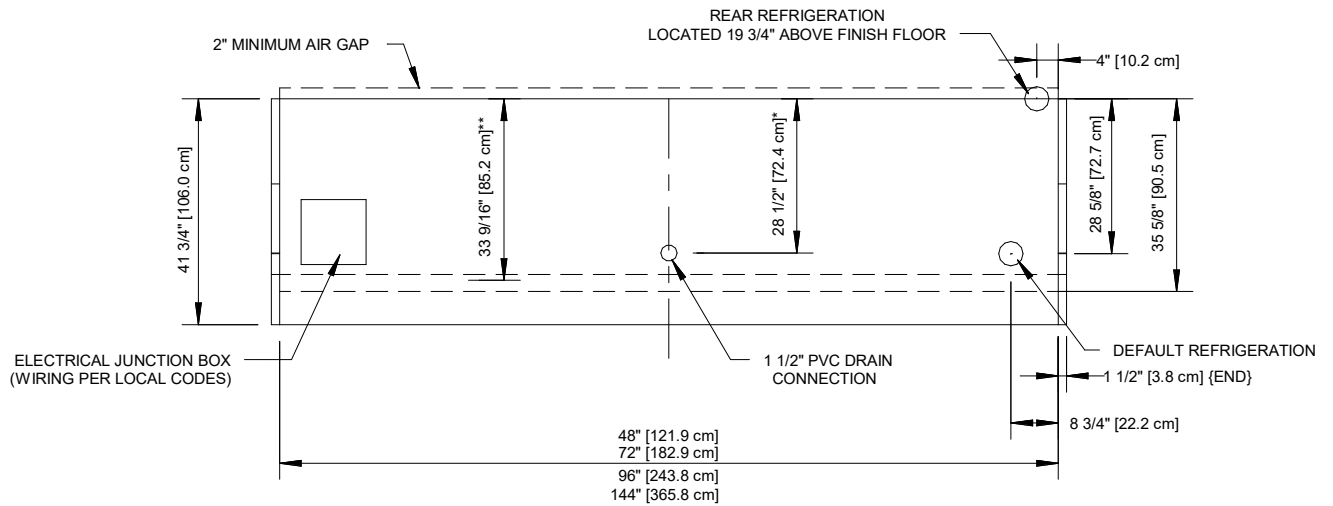
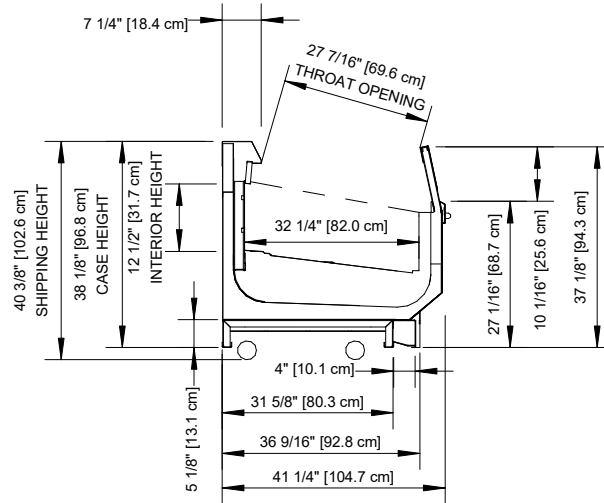

NOTES:

- * : STUB-UP AREA
- ** : RECOMMENDED STUB-UP CENTERLINE FOR ELECTRICAL AND HUB DRAINS

• Ends add approximately 1" to case height.



ALL MEASUREMENTS ARE TAKEN PER ASHRAE-72-2005 SPECIFICATIONS. HILLPHOENIX REFRIGERATED DISPLAY CASES FOR SALE IN THE UNITED STATES MEET OR EXCEED DEPARTMENT OF ENERGY 2017 REQUIREMENTS.

OMMQA

Rev. Date	Rev. #	Rev. Title
9-30-20	1	SOLOCHILL V5
03-16-20	0	SOLOCHILL V4