

ON5DMHX-NRG 4', 6', 8' & 12' High Narrow Multi-Deck Merchandiser with Synerg-E™ Beverage / Dairy / Bakery / Cut Produce / Produce

GENERAL NOTES:

- "---" indicates that the feature is not an option on this case model and/or the data is not available at this time.
- LED lights only.
- Maximum of 5 rows of Standard Output LED lighted shelves.

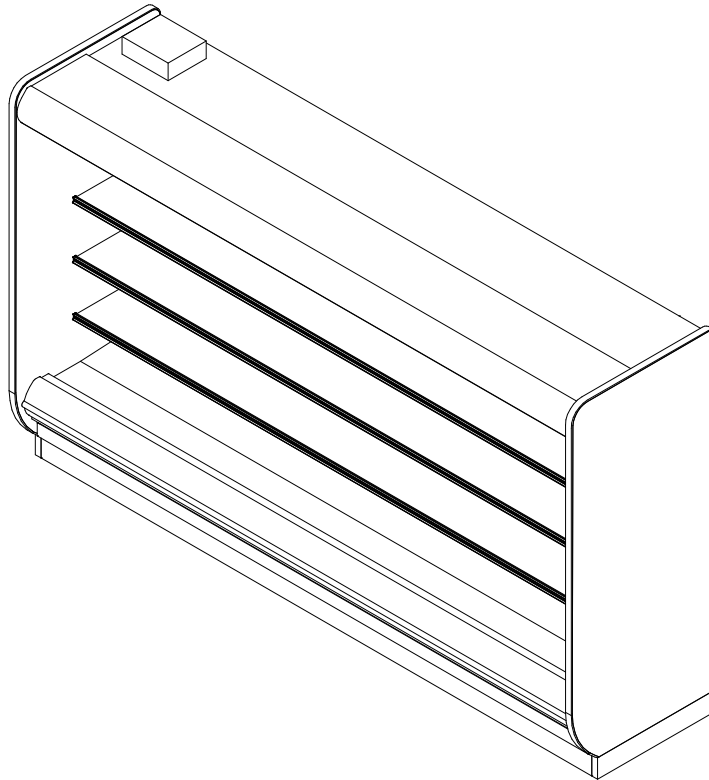

SHIPPING WEIGHT	
Case	Weight
ON5DMHX-NRG	---



ALL MEASUREMENTS ARE TAKEN PER ASHRAE-72 SPECIFICATIONS. HILLPHOENIX REFRIGERATED DISPLAY CASES FOR SALE IN THE UNITED STATES MEET OR EXCEED DEPARTMENT OF ENERGY 2017 REQUIREMENTS.

ON5DMHX-NRG

Rev. Date	Rev. #	Rev. Title
07-15-21	10	ENDVIEW UPDATE
05-19-21	9	NOTE UPDATE



ON5DMHX-NRG

4', 6', 8' & 12' High Narrow Multi-Deck Merchandiser with Synerg-E™
Beverage / Dairy / Bakery / Cut Produce / Produce

ELECTRICAL DATA			
Case Length	Fans Per Case	High Efficiency Fans	
		120 Volt	
		Amps	Watts
4'	1	0.23	18.0
6'	2	0.47	35.0
8'	2	0.47	35.0
12'	3	0.70	53.0

LIGHTING DATA					
Case Length	Lights per row	Clearvoyant v4 LED Lighting (Per Light Row)			
		Standard Power (Cornice or Shelf)		High Power (Cornice Only)	
		120 Volts		120 Volts	
		Amps	Watts	Amps	Watts
4'	1	0.05	5.9	0.12	14.9
6'	2	0.08	9.4	0.20	23.8
8'	2	0.10	11.8	0.25	29.9
12'	3	0.15	17.7	0.37	44.7

GUIDELINES AND CONTROL SETTINGS							
Application	Front Sill height	BTUH/ft		Superheat Set Point @ Bulb (°F)	Evaporator (°F)	Discharge Air (°F)	Discharge Air Velocity (FPM)
		Conventional	Parallel				
Beverage/Bulk Produce	2.5" Extended	1231	1200	6 - 8	34	37	210
Beverage/Bulk Produce	5" Extended	1209	1175	6 - 8	34	37	210
Beverage/Bulk Produce	7.5" Extended	1188	1155	6 - 8	34	37	210
Beverage/Bulk Produce	Std. Dairy	1270	1235	6 - 8	34	37	210
Dairy/Deli/Cut Produce	2.5" Extended	1611	1410	6 - 8	28	31	210
Dairy/Deli/Cut Produce	5" Extended	1583	1385	6 - 8	28	31	210
Dairy/Deli/Cut Produce	7.5" Extended	1560	1365	6 - 8	28	31	210
Dairy/Deli/Cut Produce	Std. Dairy	1651	1445	6 - 8	28	31	210

DEFROST CONTROLS			
Application	Defrosts Per Day	Timed-Off Defrost	
		Fail-Safe (Min)	Termination Temp (F)
Beverage/Bulk Produce	2	30	47
Dairy/Deli/Cut Produce	6	40	47

NOTES:

- "---" indicates that the feature is not an option on this case model and/or the data is not available at this time.
- Listed BTUH/ft data represent unlighted shelves. For LED lighting, add 9 BTUH/ft per row of lighted shelving.
- BTUH load increases by 132 BTUH/ft when aftermarket merchandising accessories are utilized.
- Listed evaporator temperature represents unlighted shelves. For lighted shelves and/or aftermarket merchandising accessories, reduce the listed evaporator temperature by 2°F.
- Conventional Discharge Air Control – Recommended Settings: Cut-In Temp = Discharge Air + 2°F; Cut-Out Temp = Discharge Air - 2°F.
- Listed discharge air velocity represents the average velocity immediately after defrost.
- Temperature and defrost settings listed above are recommended start-up settings. Final operational settings may need to be adjusted for the store conditions in which the case operates.
- The recommended evaporator temperatures may need to be adjusted based on system setup, store conditions, etc. The minimum recommended evaporator temperature is 4°F below the listed evaporator temperature.
- The published evaporator temperature for zeotropic refrigerants represents the midpoint between dew and bubble points.



ON5DMHX-NRG



ALL MEASUREMENTS ARE TAKEN PER ASHRAE-72 SPECIFICATIONS. HILLPHOENIX REFRIGERATED DISPLAY CASES FOR SALE IN THE UNITED STATES MEET OR EXCEED DEPARTMENT OF ENERGY 2017 REQUIREMENTS.

Rev. Date	Rev. #	Rev. Title
07-15-21	10	ENDVIEW UPDATE
05-19-21	9	NOTE UPDATE

Hillphoenix
A DOVER COMPANY

ON5DMHX-NRG

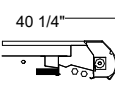
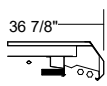
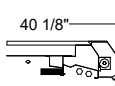
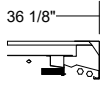
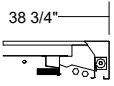
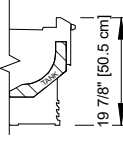
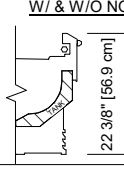
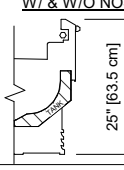
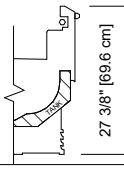
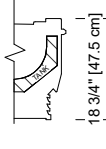
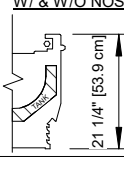
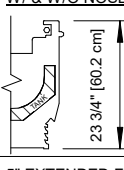
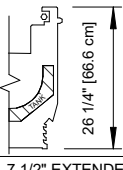
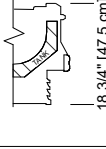
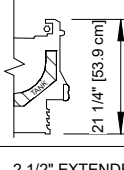
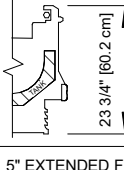
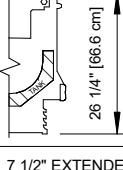
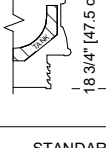
4', 6', 8' & 12' High Narrow Multi-Deck Merchandiser with Synerg-E™
Beverage / Dairy / Bakery / Cut Produce / Produce

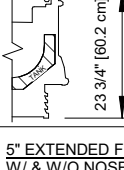
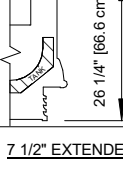
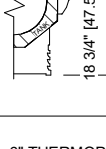
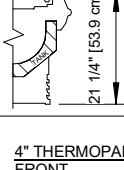
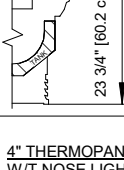
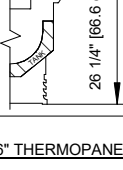
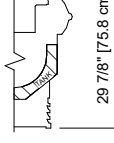
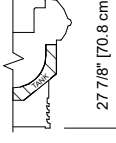
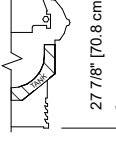
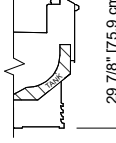
CORNICHE OPTIONS	CURVED CORNICHE	CURVED CORNICHE WITH NIGHT COVER	FACETED CORNICHE	FACETED CORNICHE WITH NIGHT COVER	FLAT CORNICHE	FLAT CORNICHE WITH STANDARD NIGHT COVER
						
FRONT OPTIONS	FLAT FRONT 2	STANDARD FRONT  19 7/8" [50.5 cm]	2 1/2" EXTENDED FRONT W/ & W/O NOSE LIGHT  22 3/8" [56.9 cm]	5" EXTENDED FRONT W/ & W/O NOSE LIGHT  25" [63.5 cm]	7 1/2" EXTENDED FRONT  27 3/8" [69.6 cm]	
	FLAT FRONT	STANDARD FRONT  18 3/4" [47.5 cm]	2 1/2" EXTENDED FRONT W/ & W/O NOSE LIGHT  21 1/4" [53.9 cm]	5" EXTENDED FRONT W/ & W/O NOSE LIGHT  23 3/4" [60.2 cm]	7 1/2" EXTENDED FRONT  26 1/4" [66.6 cm]	
	CLASSIC 2 METAL	STANDARD FRONT  18 3/4" [47.5 cm]	2 1/2" EXTENDED FRONT W/ & W/O NOSE LIGHT  21 1/4" [53.9 cm]	5" EXTENDED FRONT W/ & W/O NOSE LIGHT  23 3/4" [60.2 cm]	7 1/2" EXTENDED FRONT  26 1/4" [66.6 cm]	
	CLASSIC 2 POLYMER	STANDARD FRONT  18 3/4" [47.5 cm]	2 1/2" EXTENDED FRONT W/ & W/O NOSE LIGHT  21 1/4" [53.9 cm]	5" EXTENDED FRONT W/ & W/O NOSE LIGHT  23 3/4" [60.2 cm]	7 1/2" EXTENDED FRONT  26 1/4" [66.6 cm]	
	ORIGIN 2	STANDARD FRONT  18 3/4" [47.5 cm]	2 1/2" EXTENDED FRONT W/ & W/O NOSE LIGHT  21 1/4" [53.9 cm]	5" EXTENDED FRONT W/ & W/O NOSE LIGHT  23 3/4" [60.2 cm]	7 1/2" EXTENDED FRONT  26 1/4" [66.6 cm]	
	THERMOPANE	6" THERMOPANE FRONT  29 7/8" [75.8 cm]	4" THERMOPANE FRONT  27 7/8" [70.8 cm]	4" THERMOPANE FRONT W/T NOSE LIGHT  27 7/8" [70.8 cm]	6" THERMOPANE FRONT  29 7/8" [75.9 cm]	

OPTION PAGE NOTES:

- Tag molding materials are PVC, aluminum, or painted aluminum.
- See Ecoblade tech sheet for additional information.



ON5DMHX-NRG







ALL MEASUREMENTS ARE TAKEN PER ASHRAE-72 SPECIFICATIONS. HILLPHOENIX REFRIGERATED DISPLAY CASES FOR SALE IN THE UNITED STATES MEET OR EXCEED DEPARTMENT OF ENERGY 2017 REQUIREMENTS.

Rev. Date	Rev. #	Rev. Title
07-15-21	10	ENDVIEW UPDATE
05-19-21	9	NOTE UPDATE

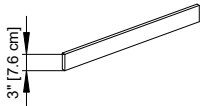
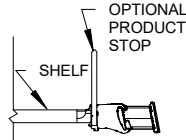

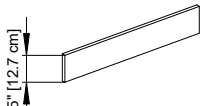
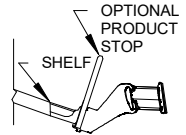
A DOVER COMPANY

ON5DMHX-NRG 4', 6', 8' & 12' High Narrow Multi-Deck Merchandiser with Synerg-E™ Beverage / Dairy / Bakery / Cut Produce / Produce

SHELF TAG MOLDING OPTIONS	PRODUCT STOP OPTIONS (ONLY APPLICABLE ON SLOTTED TM)	SHELF EDGE ENERGY SAVINGS
<p style="text-align: center;"><u>1.25" STD</u></p> 	<p style="text-align: center;"><u>3" PLEXI PRODUCT STOPS</u></p> 	<p style="text-align: center;"><u>ECO BLADE FLAT SHELF</u></p> 
<p style="text-align: center;"><u>SLOTTED</u></p> 	<p style="text-align: center;"><u>5" PLEXI PRODUCT STOPS</u></p> 	<p style="text-align: center;"><u>ECO BLADE ANGLED SHELF</u></p> 
<p style="text-align: center;"><u>ANGLED</u></p> 	<p style="text-align: center;"><u>WIRE FENCE PRODUCT STOPS</u></p> 	
<p style="text-align: center;"><u>ANGLED SLOTTED</u></p> 		

OPTION PAGE NOTES:

- Tag molding materials are PVC, aluminum, or painted aluminum.
- See Ecoblade tech sheet for additional information.



ALL MEASUREMENTS ARE TAKEN PER ASHRAE-72 SPECIFICATIONS. HILLPHOENIX REFRIGERATED DISPLAY CASES FOR SALE IN THE UNITED STATES MEET OR EXCEED DEPARTMENT OF ENERGY 2017 REQUIREMENTS.

ON5DMHX-NRG

Rev. Date	Rev. #	Rev. Title
07-15-21	10	ENDVIEW UPDATE
05-19-21	9	NOTE UPDATE



ON5DMHX-NRG 4', 6', 8' & 12' High Narrow Multi-Deck Merchandiser with Synerg-E™ Beverage / Dairy / Bakery / Cut Produce / Produce

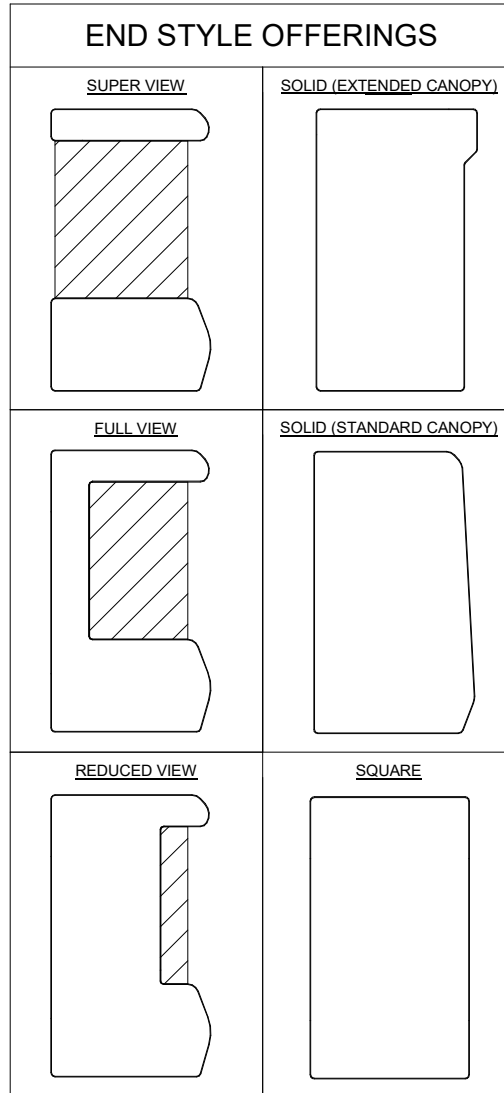

NOTES:

- Ends shown are for general use only. Shape, size, and appearance are subject to change based on engineering configuration.
- Hatched regions represent glass inserts.
- Ends are approximately 1 1/2" thick.
- Ends add approximately 1" to case height, 1/2" to the back & 1" to the front.



ALL MEASUREMENTS ARE TAKEN PER ASHRAE-72 SPECIFICATIONS. HILLPHOENIX REFRIGERATED DISPLAY CASES FOR SALE IN THE UNITED STATES MEET OR EXCEED DEPARTMENT OF ENERGY 2017 REQUIREMENTS.

ON5DMHX-NRG

Rev. Date	Rev. #	Rev. Title
07-15-21	10	ENDVIEW UPDATE
05-19-21	9	NOTE UPDATE



ON5DMHX-NRG 4', 6', 8' & 12' High Narrow Multi-Deck Merchandiser with Synerg-E™ Beverage / Dairy / Bakery / Cut Produce / Produce

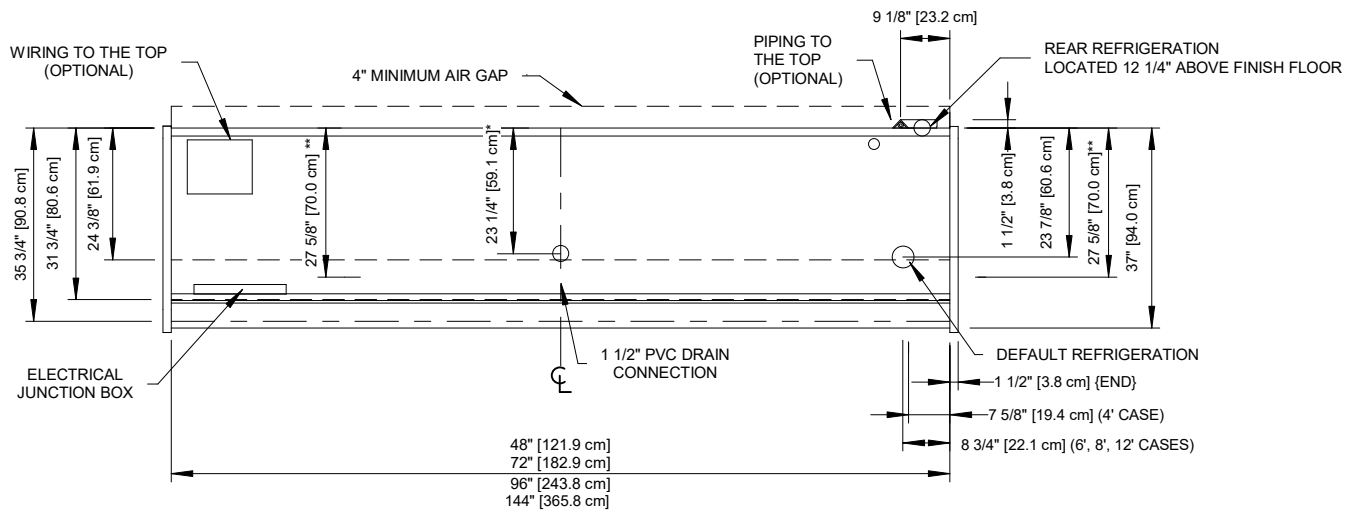
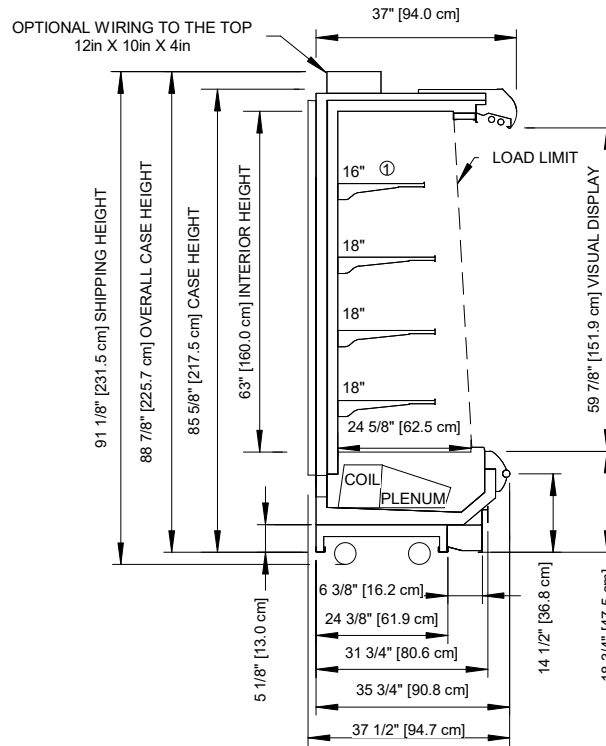

NOTES:

* :STUB-UP AREA

** :RECOMMENDED STUB-UP CENTERLINE FOR ELECTRICAL AND DRAINS

① :AVAILABLE SHELF SIZES: 10", 12", 14", 16", 18" & 20"

- Ends add approximately 1" to case height, 1/2" to the back & 1" to the front.
- Back panels add approximately 1" to the rear of the case.



ON5DMHX-NRG

ALL MEASUREMENTS ARE TAKEN PER ASHRAE-72 SPECIFICATIONS. HILLPHOENIX REFRIGERATED DISPLAY CASES FOR SALE IN THE UNITED STATES MEET OR EXCEED DEPARTMENT OF ENERGY 2017 REQUIREMENTS.

Rev. Date	Rev. #	Rev. Title
07-15-21	10	ENDVIEW UPDATE
05-19-21	9	NOTE UPDATE

Hillphoenix
A DOVER COMPANY