

# OWZGGQA

12' Wide Single-Deck Island Merchandiser  
Frozen Food

**SOLOCHILL**  
MICRO-DISTRIBUTED

## GENERAL NOTES

- "----" indicates the feature is not an option for this model and/or the data is not yet available.

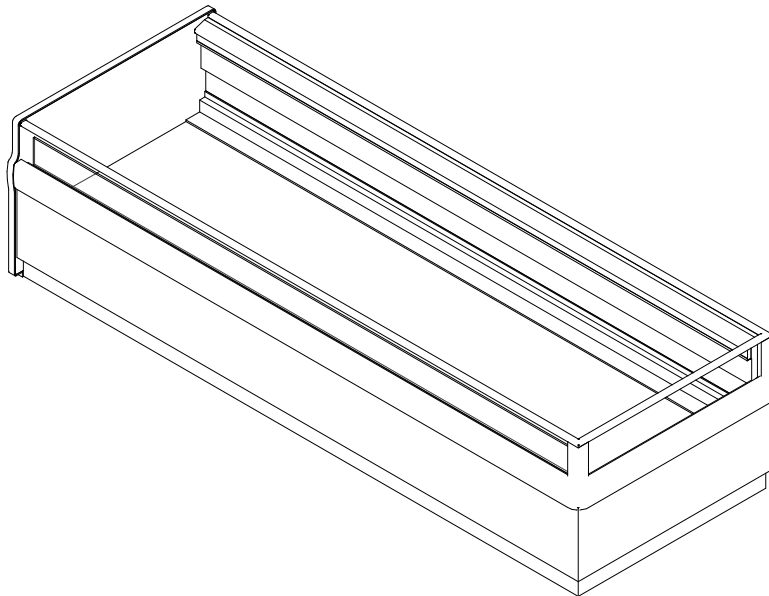

SHIPPING WEIGHT	
Case	Weight
OWZGGQA	---



ALL MEASUREMENTS ARE TAKEN PER ASHRAE-72-2005 SPECIFICATIONS. HILLPHOENIX REFRIGERATED DISPLAY CASES FOR SALE IN THE UNITED STATES MEET OR EXCEED DEPARTMENT OF ENERGY 2017 REQUIREMENTS.

## OWZGGQA

Rev. Date	Rev. #	Rev. Title
8-10-20	2	SOLOCHILL V5
3-30-20	1	OPTIONS UPDATE

**Hillphoenix**  
A DOVER COMPANY

# OWZGGQA

12' Wide Single-Deck Island Merchandiser  
Frozen Food

**SOLOCHILL**  
MICRO-DISTRIBUTED

ELECTRICAL DATA					
Case Length	Fans Per Case	High Efficiency Fans		Anti Condensate Heaters	
		120 Volt		120 Volts	
		Amps	Watts	Amps	Watts
12'	3	0.18	14.0	2.10	253.0

DEFROST CONTROLS			
Defrosts Per Day	Run Off Time (Min)	Electric Defrost	
		Fail Safe (Min)	Termination Temp (°F)
3	5	50	45

## NOTES

- "---" indicates that the feature is not an option on this case model and/or the data is not yet available.
- Listed discharge air velocity represents the average velocity at the peak of defrost.
- Temperature and defrost settings listed above are recommended start-up settings. Final operational settings may need to be adjusted for the store conditions in which the case operates.



ALL MEASUREMENTS ARE TAKEN PER ASHRAE-72-2005 SPECIFICATIONS. HILLPHOENIX REFRIGERATED DISPLAY CASES FOR SALE IN THE UNITED STATES MEET OR EXCEED DEPARTMENT OF ENERGY 2017 REQUIREMENTS.

## OWZGGQA

Rev. Date	Rev. #	Rev. Title
8-10-20	2	SOLOCHILL V5
3-30-20	1	OPTIONS UPDATE

**Hillphoenix**  
A DOVER COMPANY

# OWZGGQA

12' Wide Single-Deck Island Merchandiser  
Frozen Food



SOLOCHILL DATA			@95° Condensing Temperature	
Volts	Phase	Frequency	Wire	
208	1	60	3 Wire + Ground	
Case Length	Evaporator Temp (°F)		Discharge Air (°F)	Discharge Air Velocity (FPM)
12'	-22		-15	345

Case Length	R448A					
	Condensing Unit Model	MCA	MOP	Required Capacity	THR (BTUH)	Flow Rate
12'	DA420	36.4	40	6516	10452	3.0



ALL MEASUREMENTS ARE TAKEN PER ASHRAE-72-2005 SPECIFICATIONS. HILLPHOENIX REFRIGERATED DISPLAY CASES FOR SALE IN THE UNITED STATES MEET OR EXCEED DEPARTMENT OF ENERGY 2017 REQUIREMENTS.

## OWZGGQA

Rev. Date	Rev. #	Rev. Title
8-10-20	2	SOLOCHILL V5
3-30-20	1	OPTIONS UPDATE



A DOVER COMPANY

# OWZGGQA

12' Wide Single-Deck Island Merchandiser  
Frozen Food

**SOLOCHILL**  
MICRO-DISTRIBUTED

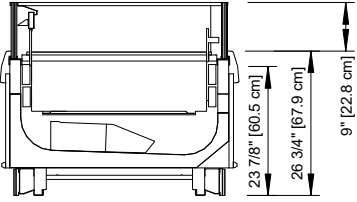
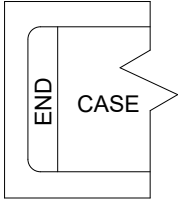
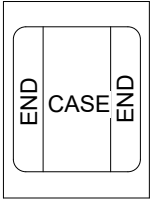
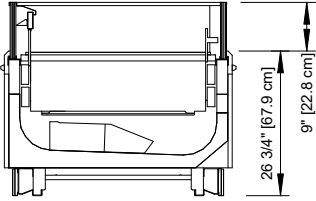
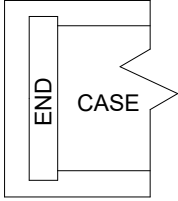
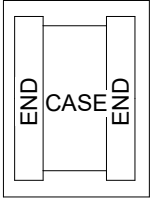
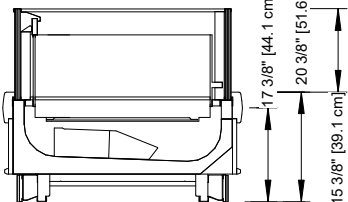
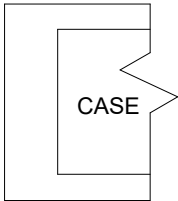
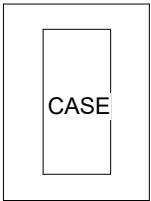
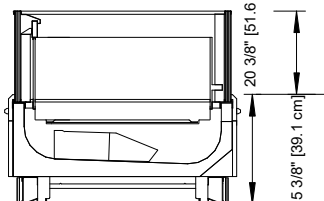
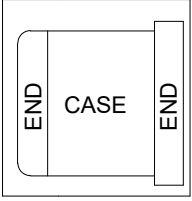
GLASS FRONT OPTIONS	END OPTIONS	
	<p><u>SINGLE WRAP END</u></p> 	<p><u>DOUBLE WRAP END</u></p> 
	<p><u>SINGLE FLAT END</u></p> 	<p><u>DOUBLE FLAT END</u></p> 
	<p><u>SINGLE JOINT (BUTT)</u></p> 	<p><u>DOUBLE JOINT (BUTT)</u></p> 
	<p><u>SINGLE WRAP, SINGLE FLAT END</u></p> 	



ALL MEASUREMENTS ARE TAKEN PER ASHRAE-72-2005 SPECIFICATIONS. HILLPHOENIX REFRIGERATED DISPLAY CASES FOR SALE IN THE UNITED STATES MEET OR EXCEED DEPARTMENT OF ENERGY 2017 REQUIREMENTS.

## OWZGGQA

Rev. Date	Rev. #	Rev. Title
8-10-20	2	SOLOCHILL V5
3-30-20	1	OPTIONS UPDATE

**Hillphoenix**  
A DOVER COMPANY

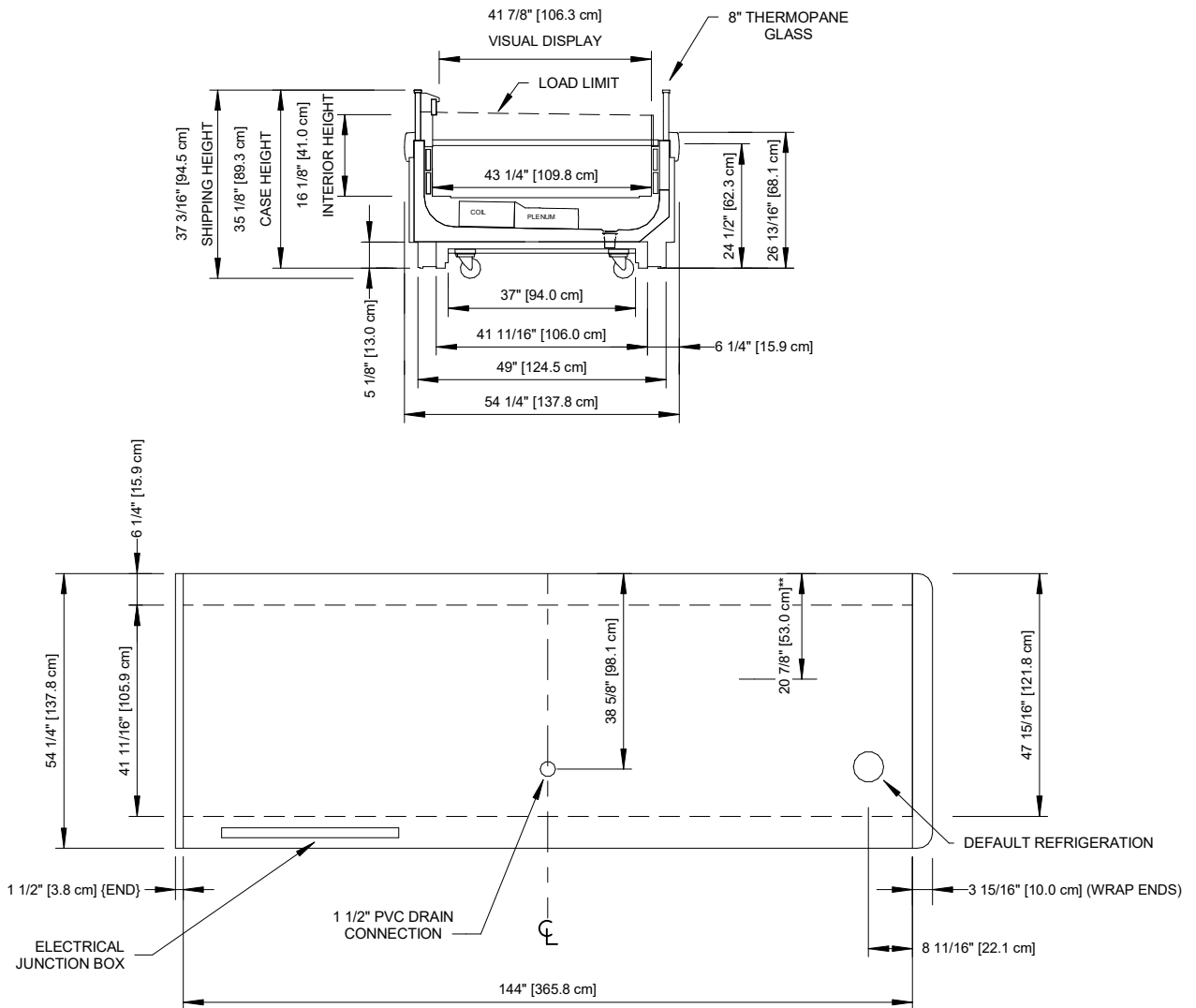

## NOTES

- \* :STUB-UP AREA
- \*\* :RECOMMENDED STUB-UP CENTERLINE FOR ELECTRICAL AND HUB DRAINS
- Ends add approximately 1" to case height.



## OWZGGQA 4

ALL MEASUREMENTS ARE TAKEN PER ASHRAE-72-2005 SPECIFICATIONS. HILLPHOENIX REFRIGERATED DISPLAY CASES FOR SALE IN THE UNITED STATES MEET OR EXCEED DEPARTMENT OF ENERGY 2017 REQUIREMENTS.

Rev. Date	Rev. #	Rev. Title
8-10-20	2	SOLOCHILL V5
3-30-20	1	OPTIONS UPDATE