

GENERAL NOTES:

- "---" Indicates that the feature is not an option on this case model and/or the data is not yet available at this time.
- 7 13/16" toekick height (optional)

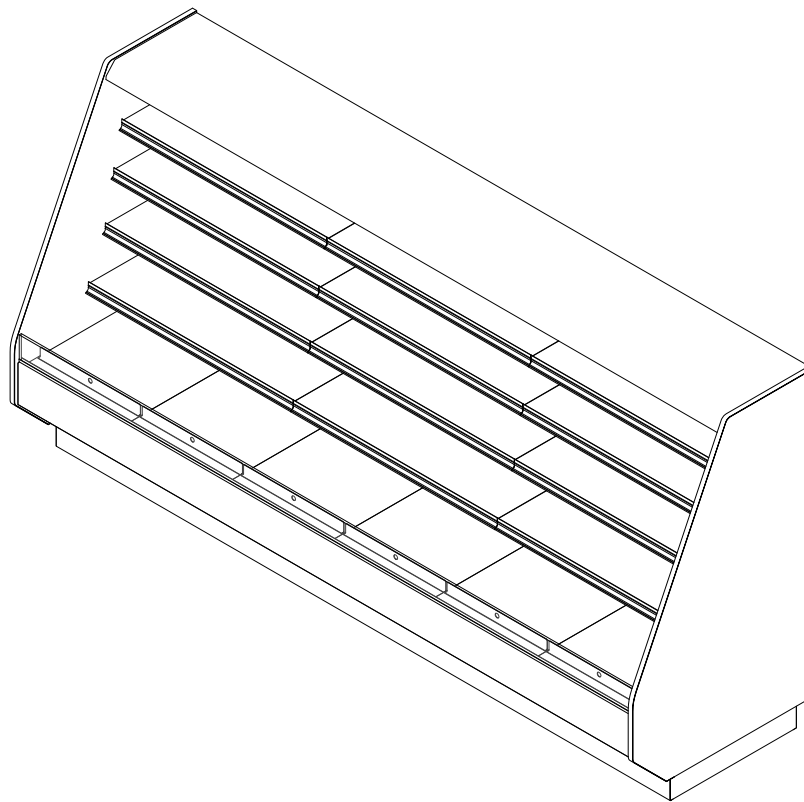

SHIPPING WEIGHT	
Case	Weight
PF-72-R	---



ENGINEERED FOR STORES WITH AMBIENT CONDITIONS NOT TO EXCEED 75° AND 55% RELATIVE HUMIDITY. DUE TO ENGINEERING IMPROVEMENTS SPECIFICATIONS MAY CHANGE WITHOUT NOTICE. ALL MEASUREMENTS ARE TAKEN PER ASHRAE-72 SPECIFICATIONS. HILLPHOENIX REFRIGERATED DISPLAY CASES FOR SALE IN THE UNITED STATES MEET OR EXCEED DEPARTMENT OF ENERGY 2017 REQUIREMENTS. NUMBERS ARE BASED ON STANDARD CASE SIZES. CONSULT ENGINEERING.

PF-72-R

Rev. Date	Rev. #	Rev. Title
03-10-22	3	DATA UPDATE
10-07-20	2	ENDVIEW UPDATE



ELECTRICAL DATA									
Case Length	Fans Per Case	High Efficiency Fans		Anti-Condensate Fans		Drain Heaters		Optional Defrost Heaters	
		120 Volts		120 Volts		120 Volts		208 Volts	
		Amps	Watts	Amps	Watts	Amps	Watts	Amps	Watts
4'	2	0.60	72.0	---	---	---	---	---	---
6'	3	0.90	108.0	---	---	---	---	---	---
8'	4	1.20	144.0	---	---	---	---	---	---
10'	4	1.50	180.0	---	---	---	---	---	---
12'	5	1.80	216.0	---	---	---	---	---	---

LIGHTING DATA						
Case Length	Lights Per Row	Light Length	Clearvoyant 4 LED Lighting (Per Light Row)			
			Standard Power (Cornice or Shelf)		High Power (Cornice)	
			120 Volts		120 Volts	
			Amps	Watts	Amps	Watts
4'	1	4'	0.05	5.9	0.12	14.9
6'	2	3'	0.08	9.4	0.20	23.8
8'	2	4'	0.10	11.8	0.24	29.8
10'	2	5'	0.12	15.0	0.30	37.0
12'	3	4'	0.15	17.7	0.36	44.7

GUIDELINES AND CONTROL SETTINGS (DX) {DIRECT EXPANSION HFC/CO2}					
BTUH/ft		Superheat Set Point @ Bulb (°F)	Evaporator (°F)	Discharge Air (°F)	Discharge Air Velocity (FPM)
Conventional	Parallel				
1131	1054	6 - 8	24	32	105

DEFROST CONTROLS {DIRECT EXPANSION HFC/CO2}							
Defrosts Per Day	Run-Off Time (Min)	Electric Defrost		Timed-Off Defrost		Hot Gas Defrost	
		Fail-Safe (Min)	Termination Temp (°F)	Fail-Safe (Min)	Termination Temp (°F)	Fail-Safe (Min)	Termination Temp (°F)
4	---	---	---	30/*20	42	---	---

NOTES:

- "---" Indicates that the feature is not an option on this case model and/or the data is not yet available at this time.
- Listed BTUH indicates unlighted shelves. Add the following for lighted shelves:
 4' Shelf LED: 36 BTUH
 4' Canopy LED: 72 BTUH
 3' Shelf LED: 27 BTUH
 3' Hi-Output LED: 54 BTUH
- Listed discharge air velocity represents the average velocity at the peak of defrost.
- Discharge air temperature values represent readings taken within the upper air channel immediately behind/upstream of the honeycomb.
- * Time-off duration for defrost with no termination control.



ENGINEERED FOR STORES WITH AMBIENT CONDITIONS NOT TO EXCEED 75° AND 55% RELATIVE HUMIDITY. DUE TO ENGINEERING IMPROVEMENTS SPECIFICATIONS MAY CHANGE WITHOUT NOTICE. ALL MEASUREMENTS ARE TAKEN PER ASHRAE-72 SPECIFICATIONS. HILLPHOENIX REFRIGERATED DISPLAY CASES FOR SALE IN THE UNITED STATES MEET OR EXCEED DEPARTMENT OF ENERGY 2017 REQUIREMENTS. NUMBERS ARE BASED ON STANDARD CASE SIZES. CONSULT ENGINEERING.

PF-72-R

Rev. Date	Rev. #	Rev. Title
03-10-22	3	DATA UPDATE
10-07-20	2	ENDVIEW UPDATE



PF-72-R

Self-Service Open Multi-Deck Refrigerator
4', 6', 8', 10' & 12' (Bakery/Beverage/Cheese/Deli)

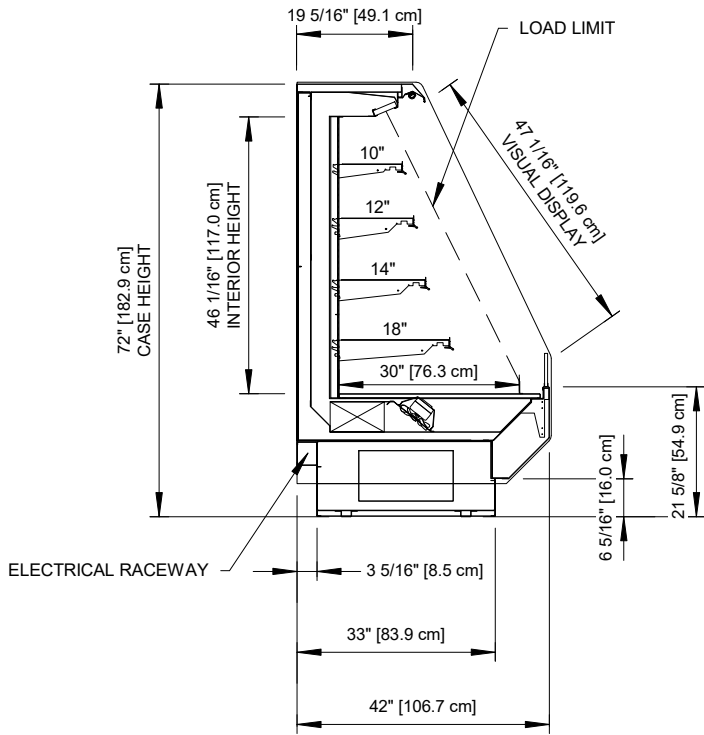

6 15/16" TOEKICK

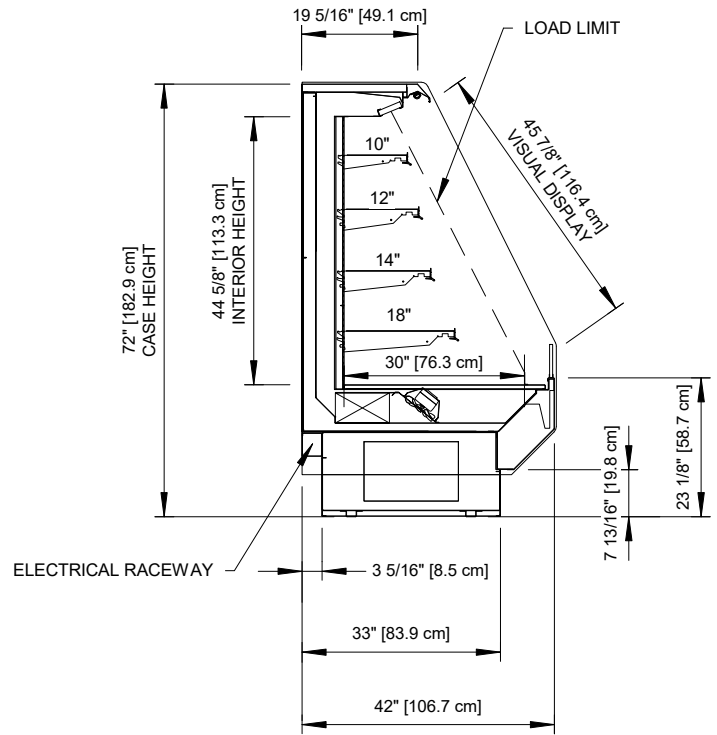

7 13/16" TOEKICK (OPTIONAL)

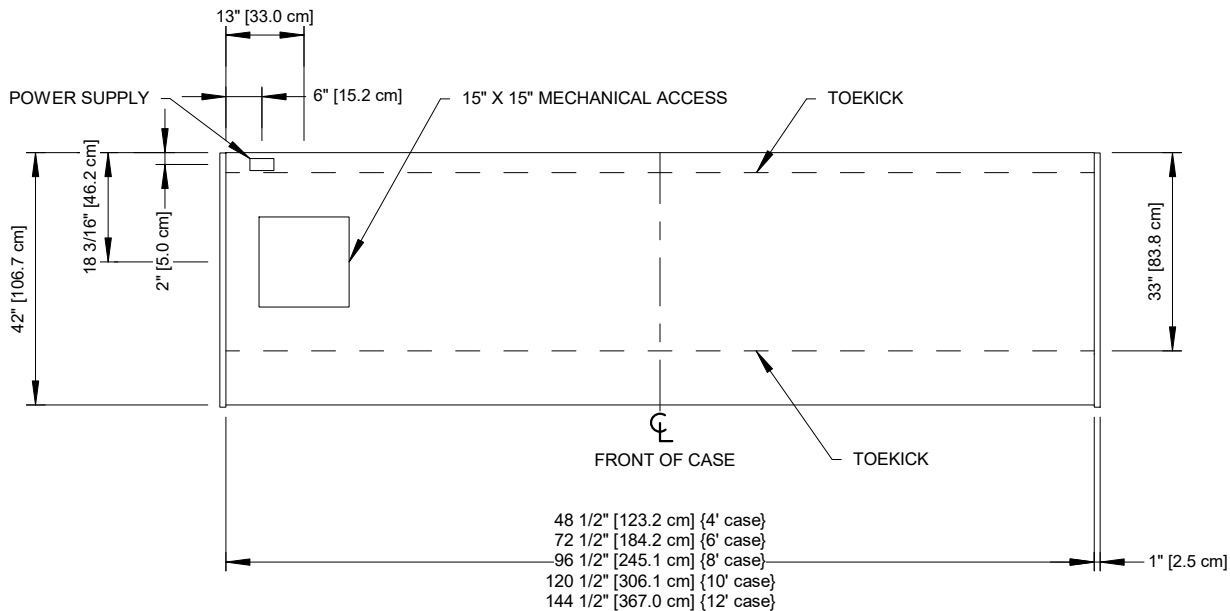

Intertek Intertek

ENGINEERED FOR STORES WITH AMBIENT CONDITIONS NOT TO EXCEED 75° AND 55% RELATIVE HUMIDITY. DUE TO ENGINEERING IMPROVEMENTS SPECIFICATIONS MAY CHANGE WITHOUT NOTICE. ALL MEASUREMENTS ARE TAKEN PER ASHRAE-72 SPECIFICATIONS. HILLPHOENIX REFRIGERATED DISPLAY CASES FOR SALE IN THE UNITED STATES MEET OR EXCEED DEPARTMENT OF ENERGY 2017 REQUIREMENTS. NUMBERS ARE BASED ON STANDARD CASE SIZES. CONSULT ENGINEERING.

PF-72-R

Rev. Date	Rev. #	Rev. Title
03-10-22	3	DATA UPDATE
10-07-20	2	ENDVIEW UPDATE



a DOVER company

PF-72-R

Self-Service Open Multi-Deck Merchandiser
4', 6', 8', 10' & 12' (Bakery/Beverage/Cheese/Deli)

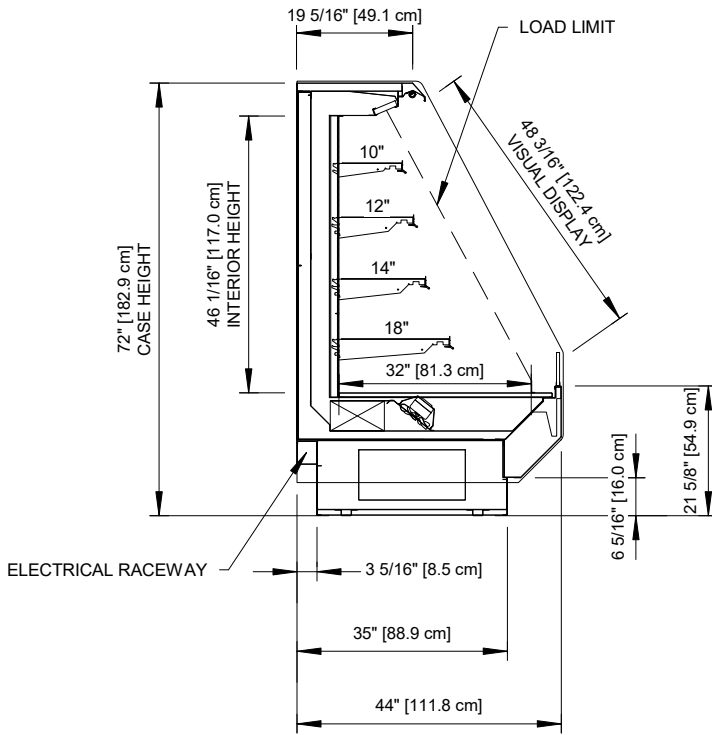

6 15/16" TOEKICK

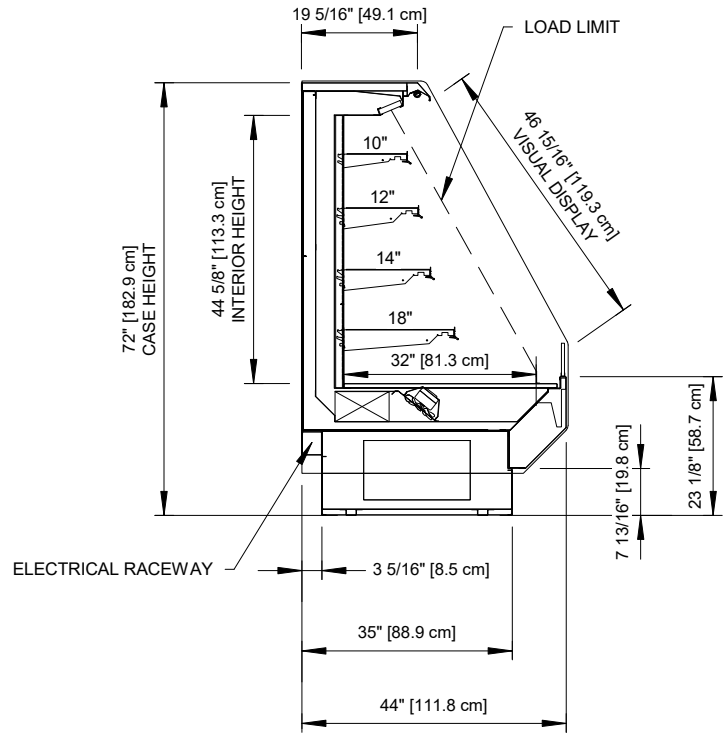

7 13/16" TOEKICK (OPTIONAL)

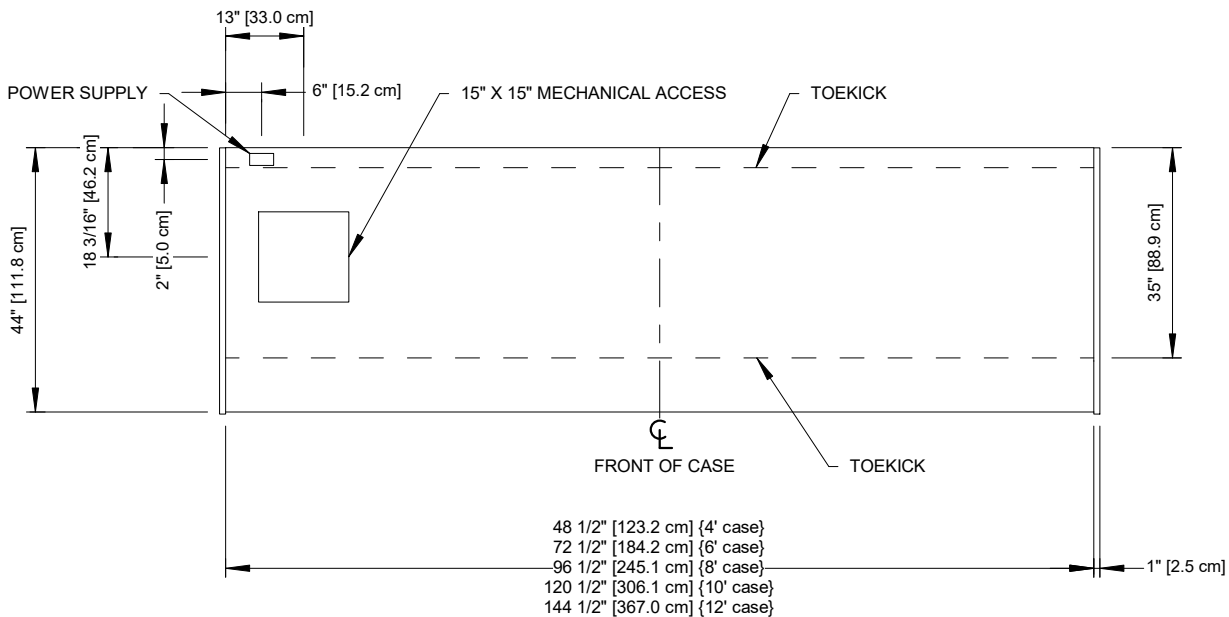

Intertek Intertek

ENGINEERED FOR STORES WITH AMBIENT CONDITIONS NOT TO EXCEED 75° AND 55% RELATIVE HUMIDITY. DUE TO ENGINEERING IMPROVEMENTS SPECIFICATIONS MAY CHANGE WITHOUT NOTICE. ALL MEASUREMENTS ARE TAKEN PER ASHRAE-72 SPECIFICATIONS. HILLPHOENIX REFRIGERATED DISPLAY CASES FOR SALE IN THE UNITED STATES MEET OR EXCEED DEPARTMENT OF ENERGY 2017 REQUIREMENTS. NUMBERS ARE BASED ON STANDARD CASE SIZES. CONSULT ENGINEERING.

PF-72-R

Rev. Date	Rev. #	Rev. Title
03-10-22	3	DATA UPDATE
10-07-20	2	ENDVIEW UPDATE



a DOVER company